



Installation Guide

Avalon HV Energy Storage System (ESS)

IMPORTANT NOTES

- Product instructions and specifications are subject to change without notice. Every attempt has been made to make this document complete, accurate and up to date. Individuals reviewing this document and installers or service personnel are cautioned, however, that Fortress Power reserves the right to make any improvements to the product, and to make changes without notice and shall not be responsible for any damages, including indirect, incidental or consequential damages caused by reliance on the material presented including, but not limited to, omissions, typographical errors, arithmetical errors or listing errors in the material provided in this document.
- Fortress Power accepts no liability for customers' failure to comply with the instructions for correct installation and will not be held responsible for upstream or downstream systems Fortress Power equipment has supplied.
- The customer is fully liable for any modifications made to the system; therefore, any hardware or software modification, manipulation, or alteration not expressly approved by the manufacturer shall result in the immediate cancellation of the warranty.
- Given the countless possible system configurations and installation environments, it is essential to verify adherence to the following:
 - There is sufficient space suitable for housing the equipment.
 - Airborne noise produced depends on the environment.
 - Potential flammability hazards.
- Fortress Power will not be held liable for defects or malfunctions arising from:
 - Improper use of equipment.
 - Deterioration resulting from transportation or environmental conditions.
 - Performing maintenance incorrectly or not at all.
 - Tampering or unsafe repairs.
 - Use or installation by unqualified persons.
- **This product contains lethal voltages and should be installed by qualified electrical or service personnel having experience with lethal voltages.**

Table of Contents

Contents

Avalon HV Energy Storage System (ESS).....	1
IMPORTANT NOTES.....	2
Table of Contents.....	3
1. INTRODUCTION.....	5
1.1. Intended Audience.....	5
1.2. Manual Instructions.....	5
1.3. System Overview.....	5
1.4. Smart Energy Panel Description.....	5
1.5. Hybrid Inverter Description.....	6
1.6. High Voltage BMS and Battery Module Description.....	6
1.7. Terminology.....	8
1.8. Notice for Disposal.....	8
2. SAFETY & WARNING.....	9
2.1. Safety.....	9
2.2. General Safety Instructions.....	9
3. SYSTEM Use Cases Functions and Operation Modes.....	12
3.1. Typical Use Cases.....	12
3.2. System Design Note.....	14
3.3. Operation Modes.....	15
4. SYSTEM Installation Preparation.....	16
4.1. Select a Location to Install.....	16
4.2. System Component Mounting and Spacing.....	17
4.3. Product Handling.....	18
4.4. Notice for Use.....	18
4.5. Battery Storage and Handling.....	18
4.6. Tools Required for System Installation.....	19
4.7. Breaker and Cable Preparation.....	20
4.8. Unpack Check List.....	22
5. SYSTEM Installation.....	27
5.1. Install Smart Energy Panel.....	27
5.2. Install HV Hybrid Inverter.....	37
5.3. Install HV Battery Pack.....	52
6. COMMISSIONING OPERATION AND MAINTAINANCE.....	61
6.1. Commissioning Check List.....	61

6.2. Power Up/Down and E-Stop Sequence	61
6.3. Commissioning with Installer App.....	62
6.4. LCD Display and Operation.....	63
6.5. System Operation and Maintenance.....	64
7. Appendix.....	66
7.1. Avalon ESS Reference Design – 200A Service Entrance.....	66
7.2. Avalon ESS Reference Design - 150A Backup with Load Shedding.....	67
7.3. Avalon Smart Energy Panel Technical Parameters	68
7.4. Avalon HV Hybrid Inverter Technical Parameters	69
7.5. Avalon HV BMS and Battery Module Technical Parameters.....	70

1. INTRODUCTION

1.1. Intended Audience

This manual is for personnel responsible for the transportation, installation, and operations of the Avalon system. Only Fortress Power Authorized Installers can perform the installation, maintenance and troubleshooting of the Avalon System. Unauthorized persons should not perform any operation to the Avalon system and should remain away from accessing the internals of the Avalon system to avoid potential hazards and voiding the warranty. If servicing the Avalon system, please fill out a support ticket prior to servicing at www.fortresspower.com/suport.

1.2. Manual Instructions

Read this **entire** manual and other related documents before transporting and installing the Avalon system. All documents must be accessible. All rights reserved including the pictures, markings and symbols used. Any reproduction or disclosure, even partially, of the contents of this manual is strictly forbidden without prior written authorization of Fortress Power LLC.

Note: In addition to this manual, the Avalon system may contain application-level guides and SOP's which should also be followed. Refer to this manual for any discrepancies.

The manual's contents will periodically be updated or revised when there are product updates. The latest manual can be acquired via visiting the Fortress Power web site at www.fortresspower.com.

1.3. System Overview

The Avalon High Voltage Energy Storage System (ESS) consists of 3 key components for Fortress Power whole home energy management and backup solution: Avalon Smart Energy Panel (SEP), Avalon HV Hybrid Inverter (PCS), and Avalon HV BMS and Battery pack (BMS/Battery). Fortress Installer/Homeowner Mobile Application (APP) provides control and monitor user interface of the system.

Avalon ESS is designed for both indoor and outdoor settings. SEP and Hybrid Inverter are wall-mount designs, the Battery pack is floor/ground mount. The Battery pack footprint is compact and battery module is stackable. The system has been evaluated per UL9540a large-scale fire for parallel Battery packs maintaining adequate safety spacing, although additional spacing requirements may be necessary for wiring access and ease of installation.

Avalon ESS combines multiple power sources (grid, PV, battery, generator etc.) and controls the power consumption by specific. The ability to control the power consumption significantly reduces wiring changes to the Main Panel while providing whole home backup. Avalon ESS can consist of an SEP with multiple Battery pack and Hybrid Inverter unit combinations, all of which are part of the UL9540 listing. Power cables to/from the 3 system components and some circuit breakers in SEP are not included. Installers should prepare to make the cables and source the breakers according to the actual system design needs. Communication cables are supplied to ease the installation.

1.4. Smart Energy Panel Description

The Avalon SEP is a central component of the Avalon Energy Storage System (ESS), designed to revolutionize home energy management. This advanced service panel is certified for versatility in residential energy systems, capable of functioning as either the main service panel or a subpanel.

Integrated Solar Installation Solutions: The SEP simplifies solar installations with an array of integrated features:

- Anti-Islanding Contactor: Ensures safe operation by disconnecting the solar panels from the grid in the event of a power outage.
- 200A Pass-Through Capability: Offers substantial current handling capacity for larger homes or higher energy demands.
- Inverter Combiner: Accommodates up to three Avalon Inverters, simplifying the system and reducing installation complexity.
- Generator Automatic Transfer Switch (ATS): Seamlessly switches to generator power during outages, ensuring continuous power supply.
- EV Charger Output: Dedicated output for electric vehicle chargers, highlighting the system's modern energy management capabilities.
- PV Inverter Input: Compatible with both retrofit solar systems and modern micro-inverter AC coupling, offering flexibility in solar energy integration.

Whole Home Backup: With its comprehensive load management and high current handling capacity, the SEP enables whole-home backup solutions. It eliminates the need for customers to choose specific critical loads, providing a more seamless and user-friendly experience. This innovative approach addresses the common challenge of critical load selection.



Figure 1.1 Smart Energy Panel

1.5. Hybrid Inverter Description

The Avalon HV Hybrid Inverter series, encompassing the Avalon HV PC76 (7.6kW) and Avalon HV PC114 (11.4kW) models, exemplifies a state-of-the-art Power Conversion System, meticulously crafted for integration with the Avalon HV Battery pack and Smart Energy Panel. This integration is strategically optimized for superior home energy utilization and to provide a failsafe power backup during grid outages. Each unit in the series is endowed with an integrated rapid shutdown transmitter and button, an Arc Fault Circuit Interrupter (AFCI), an Inverter Bypass Switch, and a Photovoltaic (PV) Switch, ensuring a comprehensive safety mechanism. Adhering to the rigorous UL 1741 standard and meeting regional regulatory requisites, the Avalon HV Hybrid Inverter series stands at the forefront of advanced energy conversion technology, ensuring both efficient energy management and compliance with the highest safety standards in the industry.



Figure 1.2 Hybrid Inverter

1.6. High Voltage BMS and Battery Module Description

The Avalon HV Battery, a cornerstone of Fortress Power's advanced residential energy storage solutions, exemplifies a high-performance and scalable system. Comprising a high-voltage Battery Management System (BMS) module and 3 to 6 battery modules, each offering 4.9 kWh capacity. It presents a harmonious blend of functionality and technology.

The BMS module features a control interface panel, wiring terminals, and a Battery Control Unit (BCU). This module plays a pivotal role in controlling and protecting the entire battery system. It facilitates seamless communication with external devices, ensuring the system's integration with other energy management components like inverters and energy panels.

The Avalon HV Battery utilizes Lithium Iron Phosphate (LFP) technology, recognized for its environmental friendliness and superior thermal stability. LFP cells offer a safer alternative to traditional lithium-ion batteries, with a reduced risk of thermal runaway and longer cycle life. An integrated heat sink further enhances the system's thermal management, working in conjunction with an active fire suppression system to provide an additional layer of safety. Moreover, the Avalon HV Battery has been rigorously tested under UL9540A

standards for large-scale fire safety.



Figure 1.3 Battery pack Front View

1.7. Terminology

In this guide, the complete energy storage system from Fortress Power is referred to as the “Avalon ESS”. Components long name, short name and abbreviation are used interchangeably:

Long Name	Short Name	Abbreviation
Avalon High Voltage Energy Storage System	Avalon ESS	ESS
Avalon Smart Energy Panel	Energy Panel/Load Center	SEP/LC
Avalon HV Hybrid Inverter	Hybrid Inverter	PCS/Inverter
Avalon HV BMS and Battery pack	Battery pack	Battery
Fortress Installer/Homeowner Mobile Application	Mobile App	App

FP = Fortress Power
 ESS = Energy Storage System
 HV = High Voltage (>60V)
 SEP = Smart Energy Panel
 LC = Load Center
 PCS = Power Conversion System
 BMS = Battery Management System
 BMU = Battery Management Unit
 BCU = Battery Control Unit
 RCMCU = Avalon SEP Master Control Unit
 Gateway = Avalon SEP built-in communication Gateway
 HMI = Human Machine Interface, also known as SEP LCD screen

NEC = National Electric Code
 NPFA = The National Fire Protection Association
 CSA = Canadian Standards Association
 PPE = Personal Protective Equipment
 SOP = Standard Operating Procedure
 SOC = State of Charge
 OCPD = Over Current Protection Device

1.8. Notice for Disposal

This product shall not be disposed of with household waste. It should be segregated and brought to an appropriate collection point to enable recycling and avoid potential impacts on the environment and human health. Local rules in waste management should be respected.

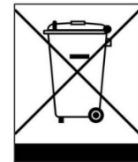

2. SAFETY & WARNING

2.1. Safety

The following types of safety instructions and general information appear in this document as described below:



DANGER

“Danger” indicates a hazardous situation which if not avoided, will result in death or serious injury.



WARNING

“Warning” indicates a hazardous situation which if not avoided, could result in death or serious injury.



CAUTION

“Caution” indicates a hazardous situation which if not avoided, could result in minor or moderate injury.



NOTE

“Note” provides tips that are valuable for the optimal operation of your product.



WARNING: Risk of fire

Despite careful construction, electrical devices can cause fires.

- Do not install the SEP in an area containing flammable materials or gases.
- Do not install the SEP in a potentially explosive atmosphere.

2.2. General Safety Instructions



WARNING

Electrical installations must be done in accordance with the local and national electrical safety standards.



WARNING

Do not touch any internal parts until 5 minutes after disconnection from the utility grid, PV array, and battery.



CAUTION

Risk of electric shock - do not remove cover. There are no user serviceable parts inside, refer service to qualified and accredited service technicians.



WARNING

Operations must be accomplished by a licensed electrician, or a person authorized by Fortress Power.



WARNING

Installers must wear personal protective equipment during the entire installation process in case of electrical hazards.



NOTE

Please refer to the product manual and all application-level guides and SOP's before installation and configuration of the ESS.



WARNING

To reduce the risk of fire, over-current protective devices (OCPD) are required for all circuits connected to the ESS components. The OCPD shall be installed per local requirements.



NOTE

Before applying power to the system, verify the polarity of all connections with a standard voltmeter.



WARNING

Do not connect PV array positive (+) or negative (-) to ground, doing so could cause serious damage to the inverter.



CAUTION

The PV conductors are energized with high voltage DC when the PV modules are exposed to sunlight.



CAUTION

The surface temperature of the inverter can reach up to 75°C (167°F). To avoid risk of burns, do not touch the surface of the inverter while it is operating. The inverter must be installed out of direct sunlight exposure.



WARNING

Reverse polarity of the battery terminals will void the warranty and damage the battery. Do not short-circuit the battery. Do not connect Battery positive (+) or negative (-) to ground, doing so could cause serious damage to the battery.



CAUTION

Do not install Avalon HV Battery in existing systems or mix Avalon HV Battery with other brands or chemistries; do not mix other Fortress Power batteries from different installations, customers, or job sites.



WARNING

Do not disassemble or modify the battery. If the battery casing is damaged, do not touch the leaking parts.



CAUTION

Disconnecting the battery while under load or charging may result in contactor connection failure. Turn off load or charging source before disconnecting with HV Battery.



CAUTION

During battery installation, the power grid and PV input must be cut off. Wiring must be performed by professionals. The battery pack cannot be serviced by the user. High voltage or current is present in the device. Electronic components inside the battery compartment are susceptible to electrostatic discharge.



WARNING

The ambient temperature will affect the battery performance, please follow the instructions to set the system parameters.



WARNING

Various failures of the product may cause leakage of electrolyte or combustible gas. Please observe the following precautions:
Explosion risk

- Do not subject the battery pack to strong shocks.
- Do not crush or puncture the battery compartment.
- Do not throw battery packs into the fire.

Fire risk

- Do not expose the battery pack to temperatures exceeding 122°F.
- Do not place the battery pack near a heat source such as a fireplace.
- Do not expose the battery pack to direct sunlight.
- Do not allow battery connectors to encounter conductive objects such as wires.

Electric shock risk

- Do not disassemble the battery pack.
- Do not touch the battery compartment with wet hands.
- Do not expose the battery pack to moisture or liquids.
- Please keep the battery pack away from children and animals.
- During operation, do not wear watches, bracelets, rings, and other conductive items.

Risk of damage the battery pack

- Do not expose battery pack to liquids.
- Do not expose the battery pack to high voltage.
- Do not place anything on top of the battery compartment.



Systems using this product shall be designed and built in accordance with the NEC & local electrical codes & standards.

3. SYSTEM Use Cases Functions and Operation Modes

3.1. Typical Use Cases

While the Avalon ESS can support many versatile configurations to suit customer specific needs, the following are the typical use cases we recommend for your system design reference.

3.1.1. Whole Home Back Up

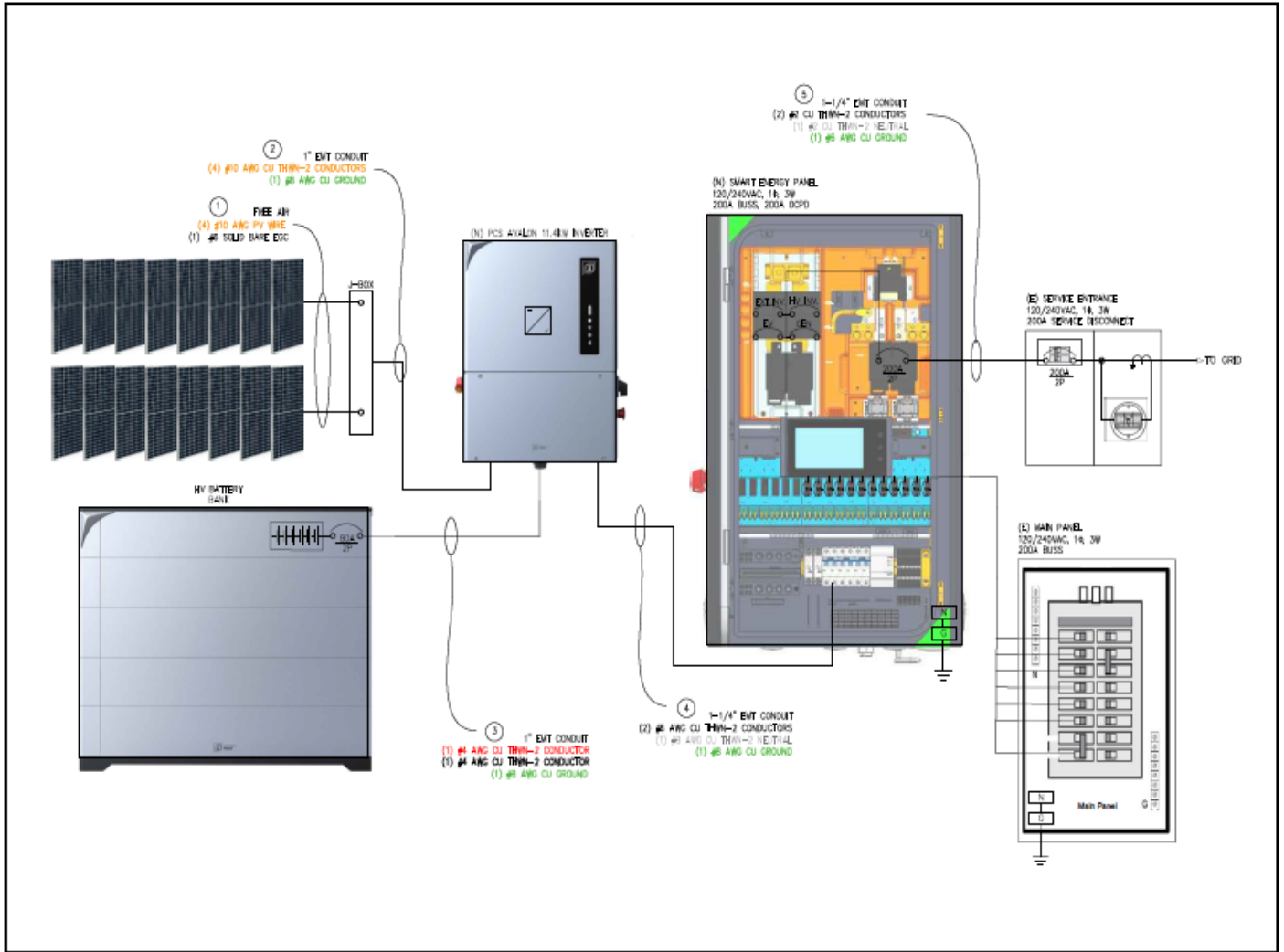

Figure 3.1 SEP as Main Panel



NOTE

When installing the Smart Energy Panel line side of the Main Panel, bonding should be moved to the Smart Energy Panel.

3.1.2. Partial Home Backup

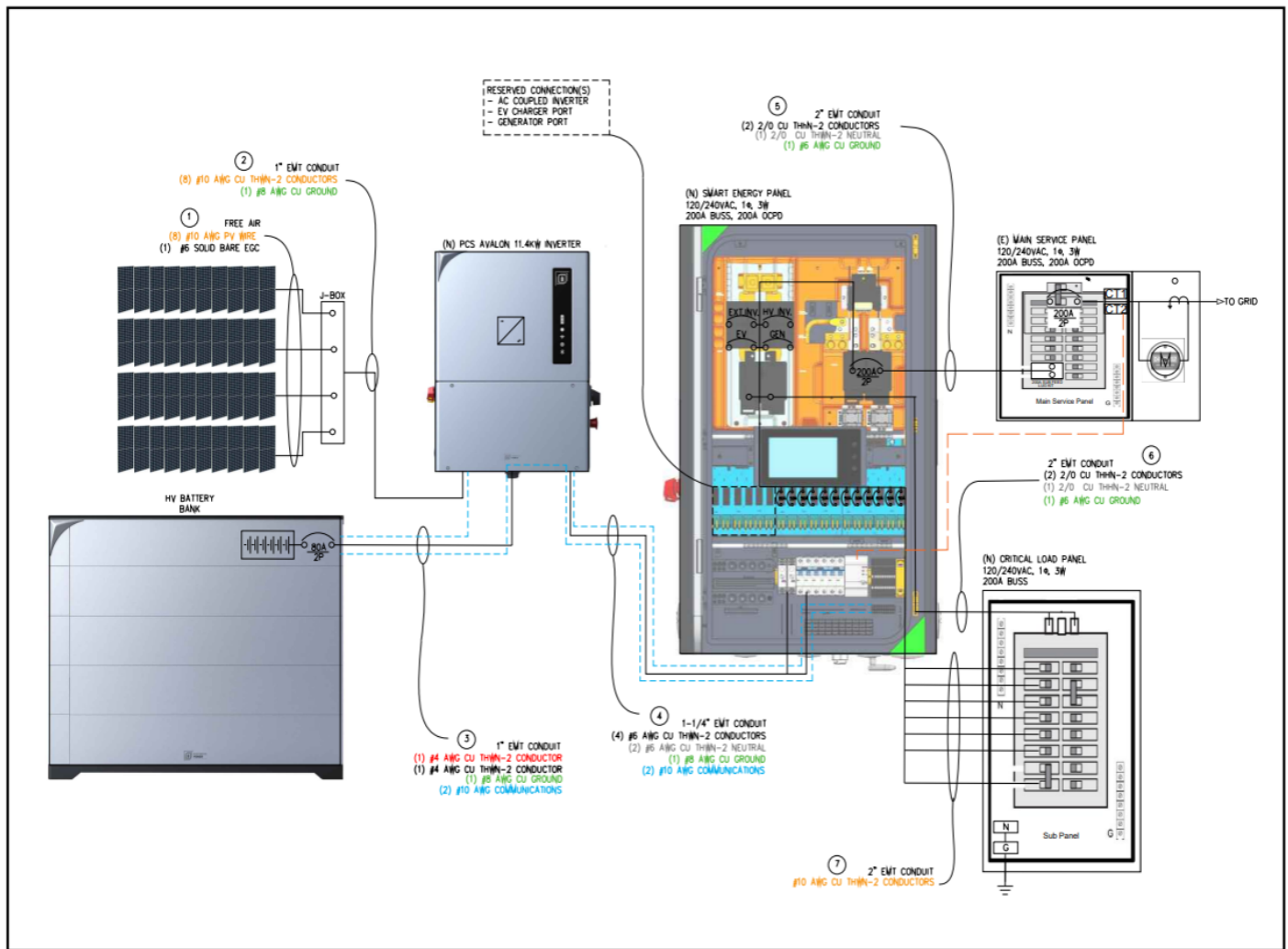

Figure 3.2 SEP as Sub Panel



NOTE

In this use case:

1. Neutral and Ground do not need to be bonded.
2. Select main Breaker size according to subpanel busbar rating (e.g. 150A, 125A).

3.2. System Design Note

3.2.1. Basic Functions

Grid-tied and backup: The Avalon Smart Energy Panel (SEP) offers a dual-functionality for both grid-tie and backup operations. It features a 200A pass-through function, allowing direct connection to a 200A main service feeder for seamless integration with the grid. For maintenance and safety, the installation of a grid bypass knife switch is recommended. In backup mode, the SEP automatically activates its load management system per customer's configuration. Please set up load management system to match the backup load equal or less than rated inverter AC output for smooth operation.

3.2.2. Using AC Coupled PV

The SEP supports AC Coupled PV up to 50A, and a maximum input of 12kW. The brand and model of the inverter is not limited.

3.2.3. Use of Generator (please consulting fortress power technical support)

The SEP requires the Generator to have 2 wire start system. The SEP will manage to switch power source from Generator and Inverter automatically. A proper sized EATON breaker is required.

3.2.4. EV Charger

The SEP Support up to 50A EV Level 2 Charger, a proper sized EATON two pole breaker is required per EV Charger's specification.

3.2.5. Emergency Stop and Manual Mode

1. Emergency Stop (E-Stop) Activation

When the Emergency Stop (E-Stop) on the SEP is activated by turning it to "Stop" position, it physically interrupts the power supply to most control boards within the system. This immediate and direct-action results in the complete disconnection of all operational circuits, leading to the cessation of all system functions. The SEP remains in this emergency state until the E-Stop switch is manually reset.

2. Resetting E-Stop to 'RUN' Position

To exit the emergency state, the E-Stop switch must be manually reset from the "Stop" to the "Run" position. This action does not automatically reinstate the previous operational mode but allows for a manual evaluation and potential reactivation of the system components, depending on the user's assessment and subsequent actions.

3. Manual Mode Engagement Post-Emergency Stop

In the aftermath of an E-Stop activation, operators can engage the SEP in a manual mode. This mode grants the user the ability to manually control the state of the system relays. While in manual mode, operators can selectively switch on and off individual relays, thus manually managing the connected circuits and loads. This capability is particularly useful for troubleshooting or system testing under controlled conditions.

4. Operational Limitation of Avalon HV Hybrid Inverter in Manual Mode

It is important to note that in manual mode, especially following an E-Stop event, the Avalon HV Hybrid Inverter remains non-operational. The inverter's functionality is dependent on certain automated control conditions and safety mechanisms that are not active in manual mode. Normal inverter operations resume only when the system is fully restored to an automated operational mode, where all control protocols and safety mechanisms are active and engaged.

5. Compliance with Safety Standards

The design of the E-Stop and manual mode functionalities in the Avalon HV ESS adheres to rigorous safety standards. These features ensure emergency response efficacy while also providing flexibility for manual control in specific scenarios. Operators are advised to adhere to all safety guidelines and operational procedures when managing the system in manual mode to ensure safe and efficient system handling.

When the E-Stop button is turned to "Stop", SEP will trigger inverter rapid shutdown. Emergency stop can also be triggered by pressing inverter rapid shutdown button, if the rapid shutdown button has been pressed, reset the button, and restart the SEP.

3.3. Operation Modes

The Avalon ESS can interconnect with the power grid and provide flexibility of 4 operation modes, default operation mode is Self-Use Mode.

3.3.1. Save Solar for My House

This mode can maximize the use of PV power generation for household electricity or store it in batteries and use it for household electricity.

- PV Power Using Priority: Load > Charging battery > export if allowed.
- Battery Charging Power: from PV, if “Charging from Grid” is allowed, can also from Grid.
- If “Time of Use” is set, follow the time and charge/discharge settings defined in “Time of Use”, for the undefined period follow Self-Use logic.

3.3.2. Sell Power to The Grid

This mode will feed excess PV generation to the grid.

- PV Power Using Priority: Load > Grid > Battery
- Load Support Priority: PV > Battery > Grid
- Battery Charging Power: from PV, if “Charging from Grid” is allowed, can also from Grid.
- If “Time of Use” is set, follow the time and charge/discharge settings defined in “Time of Use”, for the undefined period follow Feed in Priority logic.

3.3.3. Keep A Lot of Backup Power

This mode will keep battery at a Certain SOC and only use it during power outage.

- PV Power Using Priority: Battery > Load > Grid
- Load Support Priority: PV > Grid > Battery
- Battery Charging Power: from PV, if “Charging from Grid” is allowed, can also from Grid.
- Backup SOC setting range: from battery “Overdischarge SOC” to 100%.

3.3.4. Off-Grid Mode – Live Off-grid

This mode will support off-grid usage with AC Grid port disconnected.

- PV Power Using Priority: Load > Battery
- Load Support Priority: PV > Battery
- Battery Charging Power: from PV.
- Reserve SOC setting range: from battery 20% to 100%.

4. SYSTEM Installation Preparation

4.1. Select a Location to Install

When selecting a location for the Avalon ESS, the following criteria should be considered:

- The ideal location is one where the ambient temperature does not exceed 40°C (104°F)
- SEP is a wall mount design, on a load bearing wall structure.
- Hybrid Inverter is a wall mount design, on a load bearing wall structure.
- Battery pack is a floor mount design, preferably on concrete floor or pad.
- Check battery pack voltage, battery voltage should be between 45V~49V
- Battery pack voltage difference should not over 0.25V, otherwise please follow the pre-charge procedure in sector 4.5.3
- It is recommended to avoid installing any components in direct sunlight.
- Exposure to direct sunlight may cause premature wear of the mechanical components (gaskets) and user interface.
- Exposure to direct sunlight of the Hybrid Inverter may cause output power derating due to overheating.
- It is also recommended to install all components somewhere the rain and snow will not land directly on it.
- The ideal installation location is the inside of the garage or on a north-facing wall under an eave.
- Battery pack should have a protective cover/enclosure to protect it from impairment weather.
- Battery pack should be installed at a minimal dust and dirt area.
- Do not install in a living area where the prolonged presence of people or animals is expected.

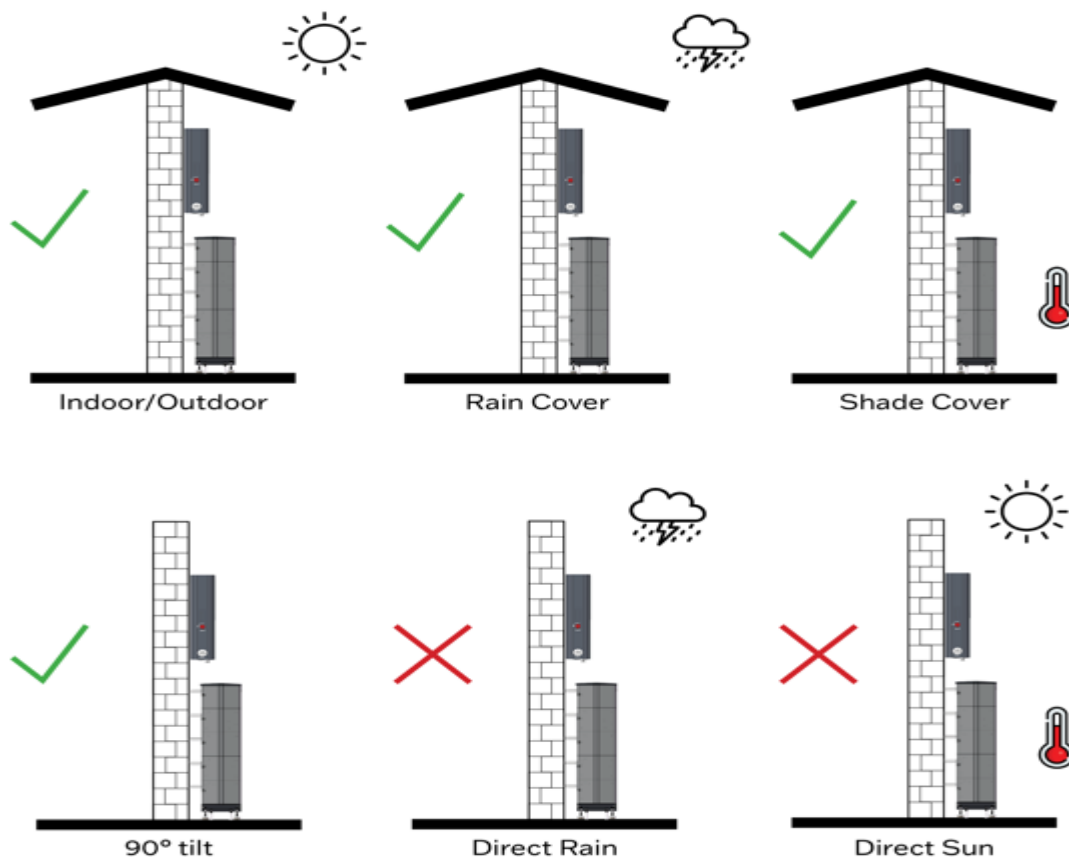

Figure 4.1 Recommended installation location



WARNING: Risk of fire

Despite careful construction, electrical devices can cause fires.

- Do not install the Avalon ESS in an area containing flammable materials or gases.
- Keep the Avalon ESS out of reach of children if children may be present.
- Do not install the Avalon ESS in a potentially explosive environment.

The ambient temperature and relative humidity of the installation environment should meet the following requirements:

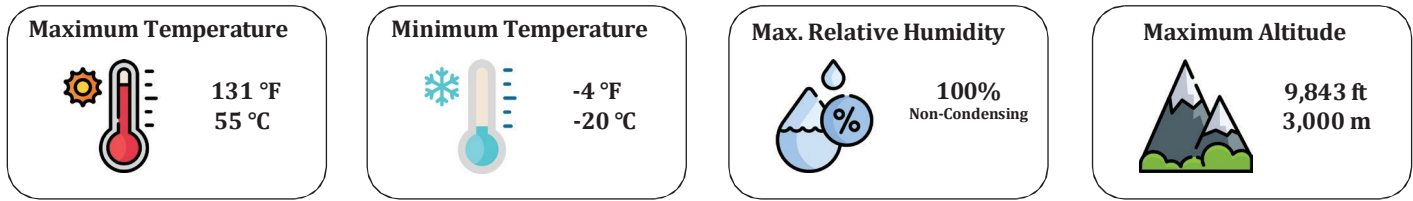

Figure 4.2 Installation environment conditions

Load bearing structure requirements:



Made of nonflammable materials

Max load bearing capacity \geq 4 times of SEP or inverter weight



Figure 4.3 Load bearing structure

4.2. System Component Mounting and Spacing

- Avalon EES is UL9540A certified, battery packs shall maintain 2.5 inches from the back wall to meet certified spacing requirements.
- A minimum side clearance of 12 inches should be kept between the system components and all other mounted equipment to allow adequate air flow and prevent overheating.
- The bottom of the SEP should be at least 6 inches above the installed Avalon Battery pack.
- The Avalon SEP must be mounted vertically.
- Adequate SEP door opening, and wire box access space must be present if installed in a confined space.
- The Hybrid Inverter must be mounted upright with a tilt of 90°. A tilt greater or less than 90° may cause the inverter output power to derate.
- When installing SEP or Hybrid Inverter above battery pack, it may be mounted above the right side of the battery pack, not directly above the BMS Module wire box cover to allow adequate working space.
- Please use the reference diagrams (Figure3.1-3.2) to help plan the conduit paths and determine the wire requirements.

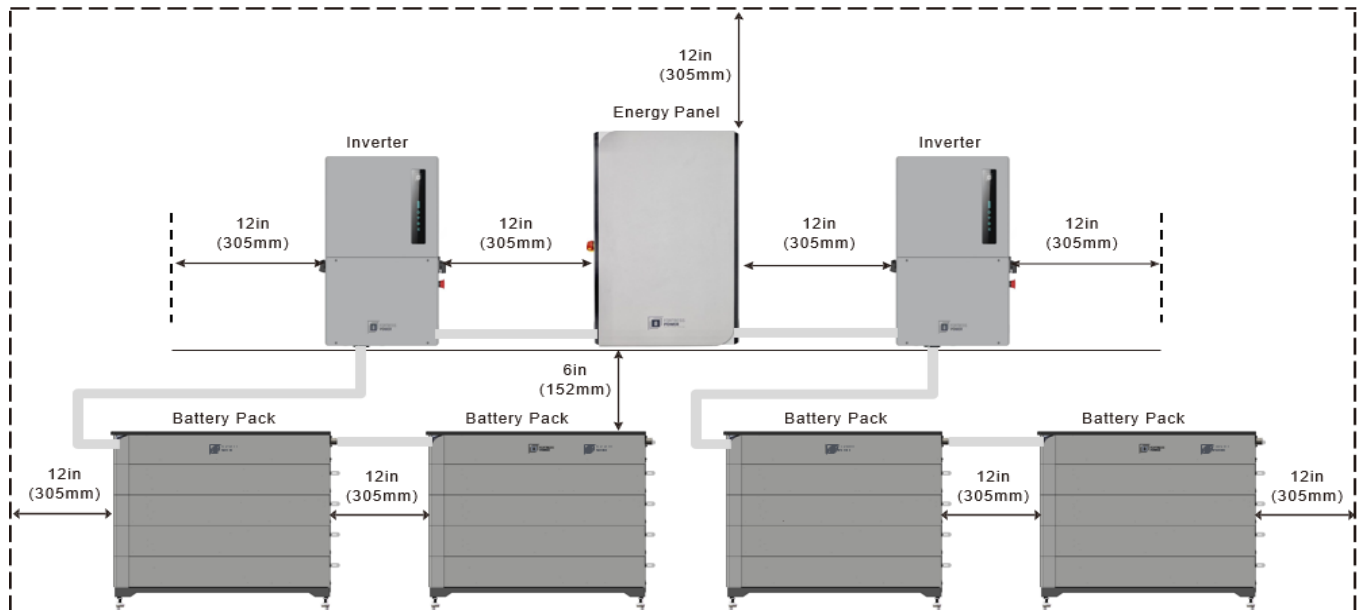

Figure 4.4 Avalon ESS Mounting Clearance

4.3. Product Handling

Please review the instruction below for handling the Avalon system components:

- Two people are required to carry and move the SEP, Hybrid Inverter and BMS/Battery Module.
- When setting the any equipment down, do it slowly and gently to prevent the internal components and the outer chassis from being damaged.
- When removing the SEP from the box, two people must use the handles on each side panel.
- When removing the Hybrid Inverter from the box, two people must use the handles integrated into the heat sink.
- Do not ship the Battery Module upside down.
- Do not lift the BMS/Battery Module by the terminal cable.
- Do not knock, drop, puncture, or crush the battery; do not expose the battery to flames, incineration, or direct sunlight.
- Do not shake the Battery Module; do not expose Battery Module to water or other liquids; do not place the Battery Module near flammable and explosive items.
- Store Battery Module in a cool and dry place on a flat surface; it is strongly recommended to handle Battery Module in a ventilated area; store out of reach of children and animals; store in a place with a minimum of dust and dirt.

4.4. Notice for Use

The Avalon ESS has been constructed according to the applicable safety and technical guidelines. Use the Avalon ESS in installations that meet the following specifications only:

- Permanent installation is required.
- The electrical installation must be compliant with all local and national regulations & standards.
- The ESS must be installed according to the instructions stated in this manual.
- The ESS must be installed according to its technical specifications.

4.5. Battery Storage and Handling

4.5.1. Battery Storage

Do not expose batteries to high temperatures. Avalon HV Battery Module should be stored under the following temperature conditions, avoiding direct sunlight. The battery circuit/BMS should be turned OFF.

Minimum Storage Temperature		Maximum Storage Temperature		Storage Duration	Storage SOC
14°F	- 10°C	95°F	35°C	1 Month	30%~50%
32°F	0°C	95°F	35°C	6 Month	30%~50%

The system should be checked monthly to ensure the system SOC does not drop below 20%. At 20% SOC, the battery will self-discharge in about 2 months. Check the voltage every 3 months, if the battery is not used for a long time, recycle it every 6 months.

4.5.2. Emergency Handling

A Battery Pack consists of multiple cells designed to prevent hazards due to failure. However, Fortress Power cannot guarantee its absolute safety.

- Battery Leak
 - If the Battery Module electrolyte leaks, avoid contact with the leaked liquid or gas. If you contact the spilled material, take the following actions immediately.
 - Inhalation: Evacuate contaminated area and seek medical attention immediately.
 - Contact with eyes: Flush eyes with running water for 15 minutes and seek medical attention immediately.
 - Skin Contact: Wash affected area thoroughly with soap and water and seek medical attention immediately.
 - Ingestion: Induce vomiting and seek medical attention immediately
- Fire
 - Make sure there is a fire extinguisher near the battery pack.
 - In the event of a fire, if possible, move the battery pack to a safe area before it catches fire.
Note: Water, FM-200 fire extinguisher, sand, carbon dioxide, dry chemical powder and foam fire extinguisher are the most effective means to extinguish the fire of lithium ferrous acid battery.
 - If the battery is not on fire and the fire has not yet spread to the battery, use an ABC fire extinguisher.

4.5.3. Charge and Discharge

If the following situations occur, the battery module must be charged before use, otherwise performance degradation and/or damage to the battery will not be covered by the warranty:

- The battery module has been transported or stored for over 6 months and it has not been operated according to the requirement of supplementary electricity.
- The battery module is in a power-off or standby state for a 6 month during transportation or storage.
- The battery module is discharged during use and reaches the undervoltage protection state.
- The battery module has not been operated according to the battery charging requirements for more than 30 days.

Do not use unqualified equipment for charging and discharging, please follow the correct instructions for usage.

- Do not discharge the battery when the battery power is exhausted.
- Do not charge or discharge a hot, deformed, or leaking battery.
- Battery output cable length should be less than 10 meters.
- Do not connect the power supply and load exceeding the power level of the battery.

Trickle charge battery procedure:

1. Check each battery module power terminal voltage to be within 0.2V of each other.
2. If the difference is above 0.2V, perform trickle charge.
3. Use a battery charger with a charging voltage limit of 53Vmax and charge current of 15A.
4. Make sure the battery output voltage is above ?V before start charging, monitor charge indicator?
5. While trickle charging is generally safe, it's important to use a charger designed for the specific type of battery and to follow this guideline. Overcharging can still be a risk if the charger malfunctions or if the wrong type of charger is used.

4.6. Tools Required for System Installation

The insulation tools and materials to be prepared are as follows:

- OSHA certified personal protective equipment (PPE).

		
Insulate Glove	Safety Glass	Safety Shoes





4.7. Breaker and Cable Preparation

Installation of Avalon ESS should be carefully planned and reference Fortress Power use case diagrams of Figure 3.1-3.2 above.

Since installation and 3rd party equipment are customer specific, when this product leaves the factory most of the OCPD and cables are **NOT** included unless explicitly stated. Customers need to source them according to their own system design needs and selected equipment power rating. Communication cables between Avalon system components are provided to ease the installation. Figure 4.1 and Table 4.1 provides OCPD locations, installation conditions and recommend models.

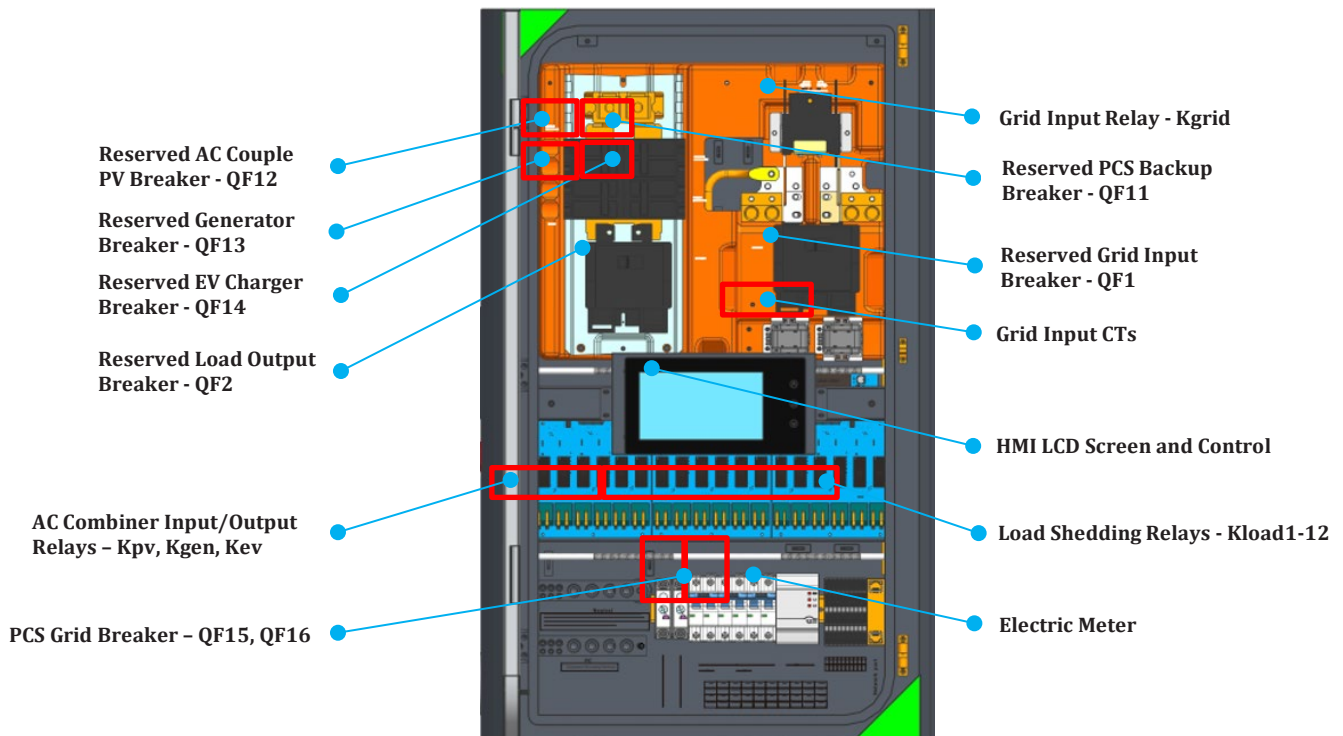

(Note: breakers are installation specific and not all are included)

Figure 4.5 SEP Major Components

Location	Definition	Installation Conditions	Recommend Model
QF1	Utility grid main input breaker	This circuit breaker is not needed if there is circuit breaker installed after the grid enters the household. If there is no circuit breaker installed after the grid enters the household, this breaker must be installed. Breaker rating depends on system design.	Eaton CSR2200N, CSR2175N, CSR2150N, CSR2125N
QF2	Load main output breaker	SEP is more than 20 meters to main panel, it must be installed, otherwise it is optional.	Eaton CSR2200N, CSR2175N, CSR2150N, CSR2125N
QF11	Hybrid Inverter backup output breaker	When installing one Hybrid Inverter, a 60A circuit breaker must be installed. When installing two Hybrid Inverters, 125A circuit breakers must be installed.	Eaton BR260, BR2125
QF12	PV Inverter AC coupled input breaker	When connecting an AC coupled PV Inverter, it must be installed, otherwise it may not be installed. Breaker rating depends on PV Inverter rating.	Eaton BR260, BR240, BR230, BR220
QF13	Generator input breaker	When connecting a generator, it must be installed, otherwise it may not be installed. (Note: This port can be used to connect the 3 rd parallel Hybrid Inverter)	Eaton BR260
QF14	EV output breaker	When connecting an EV charger, it must be installed, otherwise it may not be installed.	Eaton BR260
QF15&16	Hybrid Inverter grid input breaker	When installing Hybrid Inverter, a matching 40A (7.6kW Inverter) or 60A (11.4kW Inverter) circuit breakers must be installed.	Noark B1N1C40, B1N1C60 (Supplied with inverter)

Table 4.1 Breaker Function and Model Recommendation



NOTE

The selected circuit breaker must meet UL489 certification and pass the 1.5 times overcurrent test for 60 cycles in 6mins.

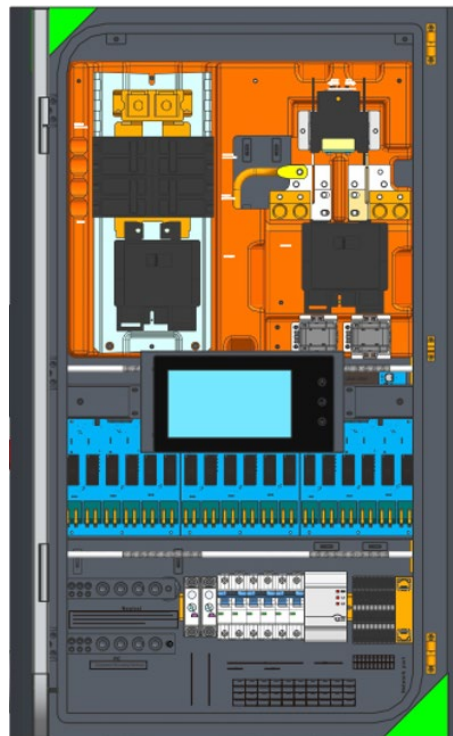



Figure 4.6 AC Grid and Backup Cable Routing Guideline

4.8. Unpack Check List

4.8.1. Smart Energy Panel Packing List

If any of these items are missing or damaged, please contact your local Fortress Power distributor.

Number	Name	Description	Unit	Qty	Picture
1	Smart energy panel	WxHxD: 21.93" x 35.43" x 9.37", 55 lbs	pc	1	
2	Wireless antenna	External antenna for Bluetooth/WiFi communication	pc	1	
3	Wall mount bracket	WxHxD: 17.72" x 14" x1.2"	pc	1	
4	Bolt and nut kit	304 stainless steel texture 2-M5x3/8" assembling bolt 8-M5x2" self-tapping screw 1-M5x1/2" self-tapping screw	kit	1	
5	Plastic expansion tube	L=2-3/8", outer diameter 5/16"	pc	8	
6	Hex wrench	M4 hex L key	pc	1	

FORTRESS POWER AVALON HIGH VOLTAGE ENERGY STORAGE SYSTEM





7	SD card	32GB SD card for HMI LCD software upgrade	pc	1	
---	---------	---	----	---	---

4.8.2. HV Hybrid Inverter Packing List

If any of these items are missing or damaged, please contact your local Fortress Power distributor.

Number	Name	Description	Unit	Qty	Picture
1	Avalon HV hybrid inverter	WxHxD: 21.87" x 34.88" x 8.62", 89.59 lbs	pc	1	
2	Mounting bracket	WxHxD: 18.74" x 13.15" x 1.5"	pc	1	
3	Stabilizing set screws	0.75" T20 screw with washer set	pc	4	
4	Ferrule	Eighteen (18) AWG20 wire ferrule Ten (10) AWG 12 wire ferrule	pc	28	
5	CAT 5 Connector		pc	6	

FORTRESS POWER AVALON HIGH VOLTAGE ENERGY STORAGE SYSTEM





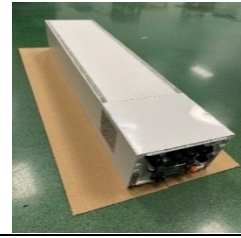

6	Antenna	Reserved	pc	1	
7	Torx T20 tool	Torx T20 L key	pc	1	
8	Breaker	Grid input breaker, 1box(2pcs C40) in PC76(7.6kW) inverter package Grid input breaker, 1box(2pcs C63) in PC114(11.4kW) inverter package	box	1	
9	Quick guide	Avalon HV Hybrid Inverter Quick Guide	pc	1	

4.8.3. HV BMS Module Packing List



If any of these items are missing or damaged, please contact your local Fortress Power distributor.

Number	Name	Description	Unit	Qty	Picture
1	BMS module top cover	Matte black, flexible, water resistant silicone cover. Dimension 41" x 8.5" x .75".	pc	1	
2	BMS module main unit	BMS Module main assembly. Dimension 38" x 8.25" x 6.5", 30.8 lbs	pc	1	

FORTRESS POWER AVALON HIGH VOLTAGE ENERGY STORAGE SYSTEM



3	Battery pack floor stand	Heavy-duty metal, power-coated black foundation built to withstand harsh environmental conditions and providing long-lasting support to battery modules and BMS module. It accepts four (4) adjustable feet if needed and can be secured to a concrete pad. Dimension 40.5"x8.25"x2".	pc	1	
4	BMS module connection kit	One (1) 36" negative power cable connect battery pack main negative back to BMS negative terminal One (1) 9.5" positive cable connect battery pack main positive back to BMS positive terminal One (1) perforated BMS metal stack mounting bracket	kit	1	
5	BMS module accessory hardware kit	Four (4) adjustable feet Four (4) 3.5" concrete anchor bolts Two (2) 2.5" plastic anchors w/screws Two (2) metal L-brackets One (1) stainless steel threaded conduit fitting 1.5" OD with O-ring One (1) RJ45 waterproof terminator One (1) 2-wire heater connector One (1) M4 hex tool One (1) M5 hex tool Eighteen (18) 1/2" M4 screws One (1) 1/2" M5 ground wire screw One (1) triangle barrier protection	kit	1	
6	Plastic end cover	ABS plastic end cover for BMS module cable/wire concealment	pc	1	
7	Cable organizer	Battery BMS external wire organizer. Work with 1" conduit fitting	PC	1	
8	Avalon System communication cable 1	Communication from BAT to Hybrid Inverter	pc	1	

FORTRESS POWER AVALON HIGH VOLTAGE ENERGY STORAGE SYSTEM

9	Avalon System communication cable 2	Communication from BAT to SEP	pc	1	
10	Avalon System communication cable 3	Communication from Inverter to SEP	pc	1	

4.8.4. HV Battery Module Packing List

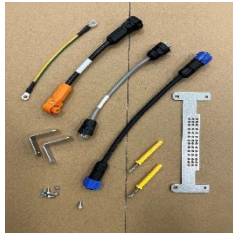
If any of these items are missing or damaged, please contact your local Fortress Power distributor.

Number	Name	Description	Unit	Qty	Picture
1	Lithium-Ion phosphate battery module	Lithium-Ion phosphate 48V battery module. Dimension 38.75" x 8.25" x .6.5", 90.4 lbs	pc	1	
2	HV battery module connection kit	One (1) 2-conductor 13" heater cable One (1) 9" battery-to-battery communications cable with RJ45 ends One (1) 9.5" battery-to-battery in-series color-coded connection cable One (1) perforated metal stack mounting bracket One (1) 8" yellow/green ground wire Two (2) 2.5" plastic anchors w/screws Two (2) metal L-brackets Nine (9) 1/2" M4 screws One (1) 1/2" M5 ground wire screw	kit	1	
3	Plastic end cover	ABS plastic battery module end cover for cable/wire concealment	pc	1	

5. SYSTEM Installation

5.1. Install Smart Energy Panel

5.1.1. SEP Overview



Figure 5.1 Front View

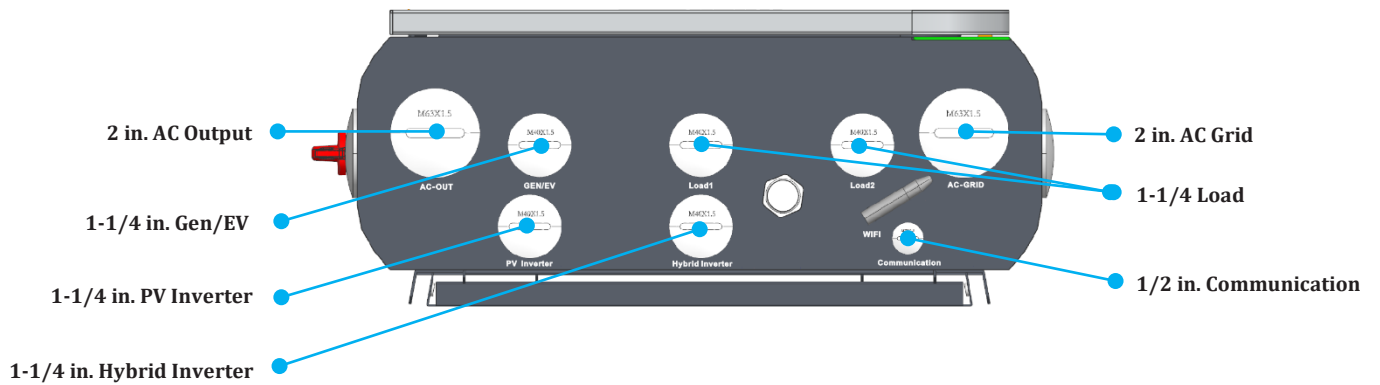

Figure 5.2 Bottom View

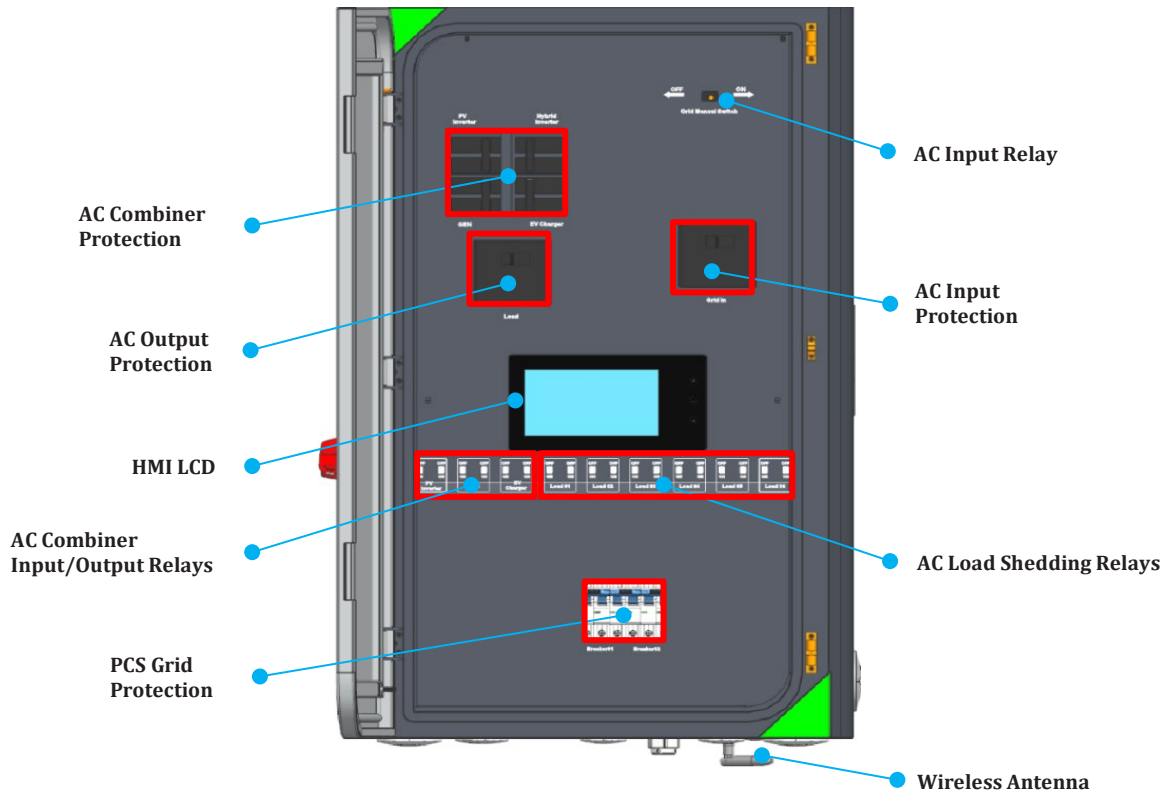

Figure 5.3 Inside Front Panel View

5.1.2. SEP Wiring Diagram

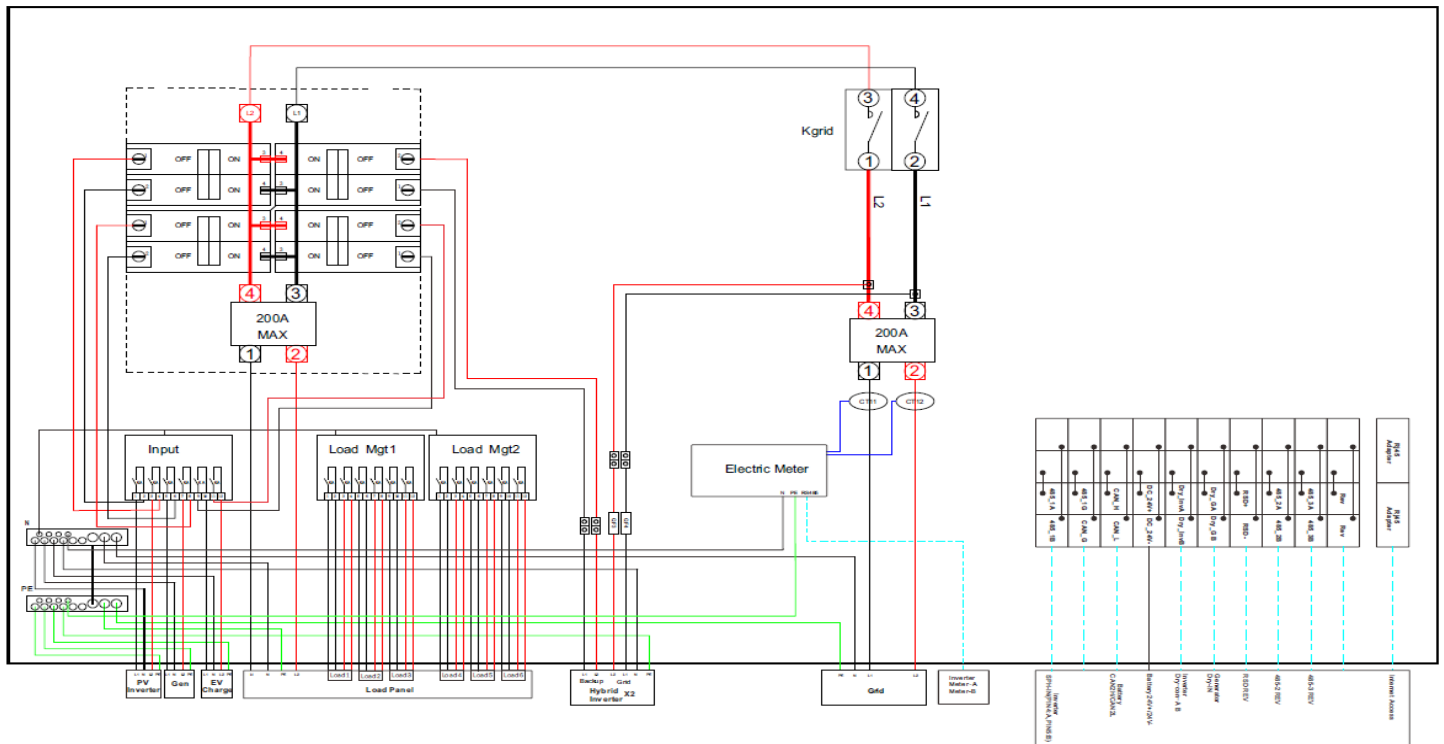

Figure 5.4 SEP Wiring Diagram

5.1.3. Install Wall Mount Bracket

- Mark drilling positions through 8 bracket mounting holes, and drill installation holes with diameter of 5/16 inch (8mm) and depth greater than 2-3/4 inches (70mm).
- Cement wall mounting is recommended, if mount on wooden structure wall, bracket need to be fixed on weight bearing stud.
- Install the nylon expansion tube and knock it into the hole.
- Use the corresponding screws and washers to install and fix the wall hanging bracket on the wall. (For the wooden structure wall, use M8 wooden screws to directly fix the hanging bracket to the stud).

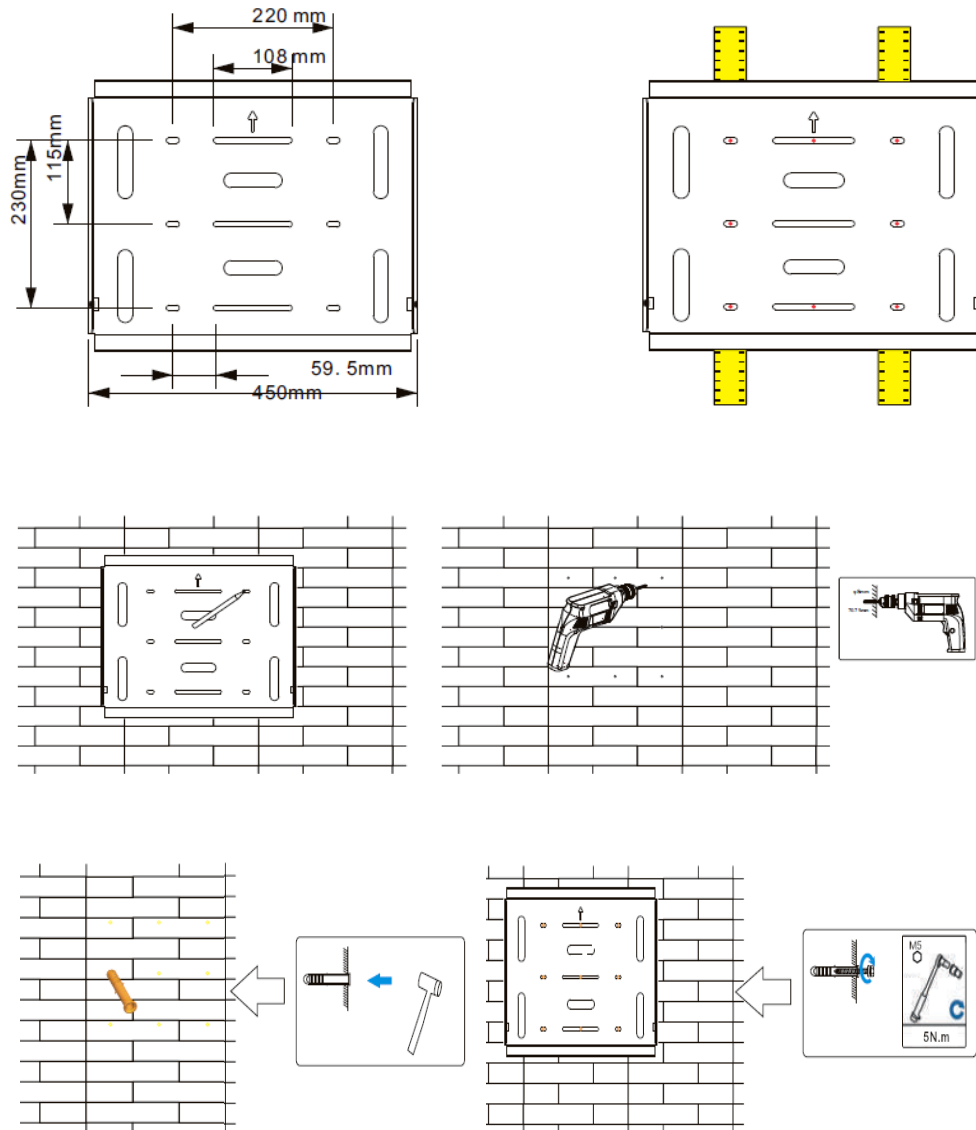

Figure 5.4 Install SEP Mounting Bracket

5.1.4. Hang SEP Cabinet

Hang the SEP cabinet on the wall bracket and use 2 M6 bolts to lock the fixing plate on both side of SEP cabinet onto the wall bracket.

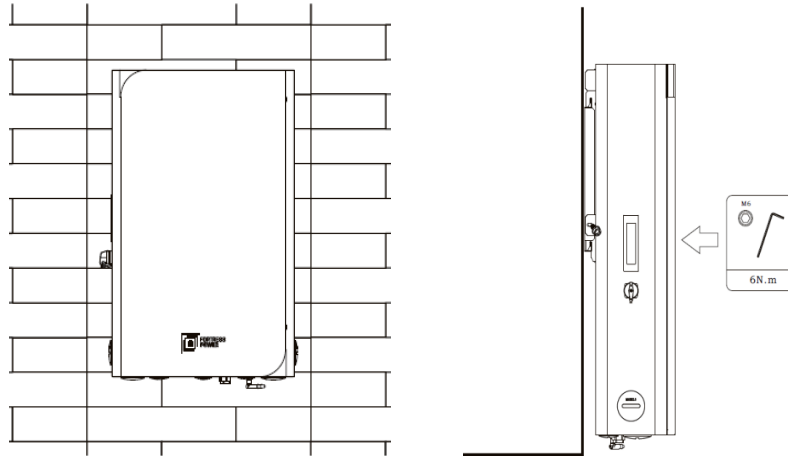

Figure 5.5 Hanging SEP Cabinet



NOTE:

Nothing should be stored directly on top, underneath, or against the SEP.

5.1.5. Install Breakers

Open the front door of the SEP and remove inside protective cover to access wiring box and install breakers. For the installation of the circuit breaker, refer to Figure 4.1 and Tabel 4.1 to select and install necessary breakers.

- Install utility grid input breaker (if used)
- Install load output breaker (if used)
- Install breaker of the AC coupled inverter (if used)
- Install breaker of the Generator (if used)
- Install breaker of the EV charger (if used)
- Install Hybrid Inverter grid input breakers (must install)
- Install Hybrid Inverter load output breakers (must install)

5.1.6. SEP Wiring Guide

SEP should use the wiring method in accordance with the NEC code. The auxiliary materials used for the sheath tube shall meet the requirements of UL514B.

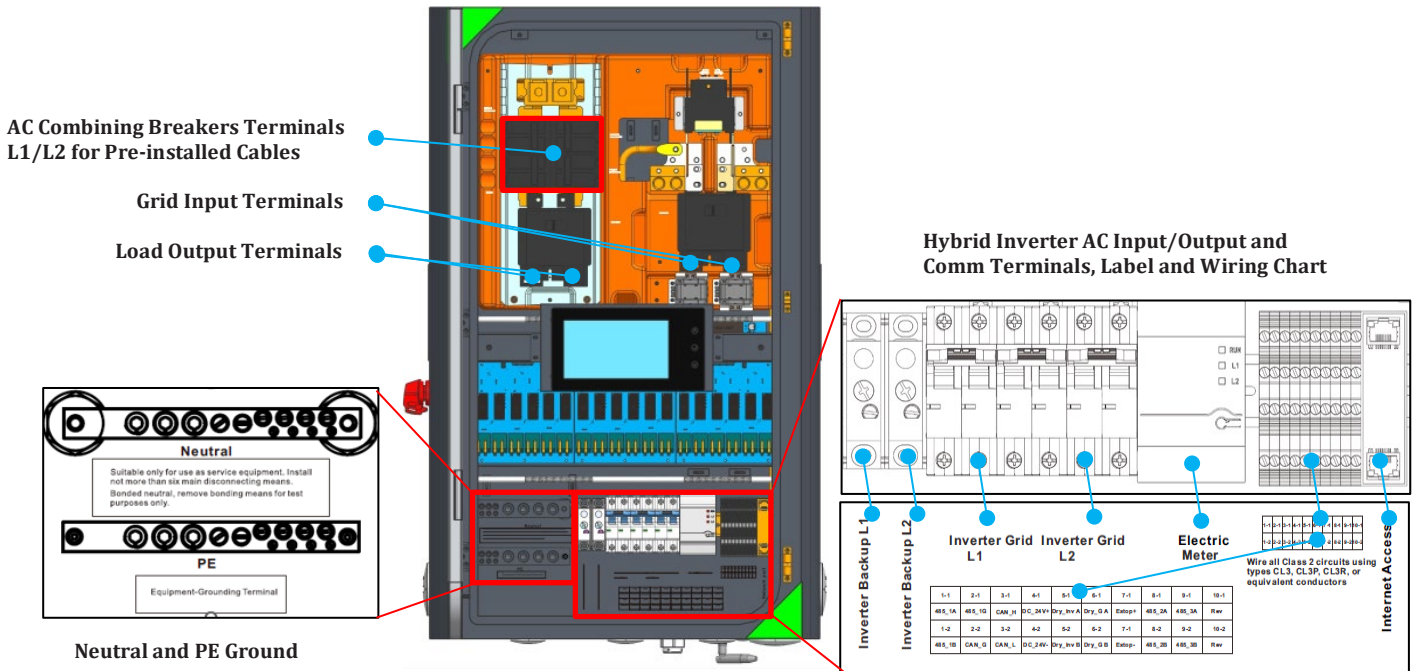

Figure 5.6 SEP Wiring Points

Wiring Order	Cabel Name	Purpose	Making Connection
1	Low voltage and Comm cables	Low voltage supply, signaling and communication to inverter and battery	Match the supplied comm cable labels with connection points names on wiring chart, terminate wires on comm terminal block ports.
2	Meter Comm cables	Meter communication to inverter	Match the supplied comm cable labels with connection points names on electric meter, terminate wires on meter terminal block ports.
3	Neutral cables	Grid neutral connection	Terminate the grid transformer N line or the main service panel N line to SEP neutral busbar. Terminate the inverter N line to SEP neutral busbar. Terminate the battery pack N line to SEP neutral busbar.
4	Ground cables	PE ground connection	Terminate the grid transformer PE line or the main service panel PE line to SEP PE busbar. Terminate the inverter PE line to SEP PE busbar. Terminate the battery pack PE line to SEP PE busbar.
5	Inverter AC grid cables	Inverter grid input connection	Terminate the inverter AC grid L1 and L2 lines to SEP Inverter Grid breaker QF15/L1 and QF16/L2 terminals.
6	Inverter AC backup cables	Inverter backup AC output connection	Terminate the inverter AC backup L1 and L2 lines to SEP Inverter Backup breaker QF11 L1 and L2 terminals.
7	AC grid input cables	AC grid input connection	Terminate the grid meter or OCPD in the main service panel L1 and L2 lines to SEP QF1 L1 and L2 terminals.
8	(If used) AC coupled inverter, Generator, EV charger AC cables	AC input/output connection	Wire equipment L1 and L2 lines to the corresponding input/output relays terminals. Terminate the pre-installed L1 and L2 lines on the corresponding breaker L1 and L2 terminals.
9	Load cables	Load control/shedding connection	Disconnect load from original panel breaker. Wire the breaker to SEP load shedding relay IN. Then connect SEP load shedding relay OUT back to the load.

Table 5.1 SEP Wiring Guideline

5.1.7. SEP Wiring Instructions

5.1.7.1. SEP to Inverter and Battery Low Voltage and Communication Connection

All low voltage and communication cables are supplied and labeled to ease the wiring. Follow the printed wiring chart inside SEP wiring area, map the wire labels against the wiring chart and insert the wire ferrules to the corresponding terminals of the terminal block. Check labels on both ends to make correct connections. A cross reference terminal map is given in Table 5.2 below.

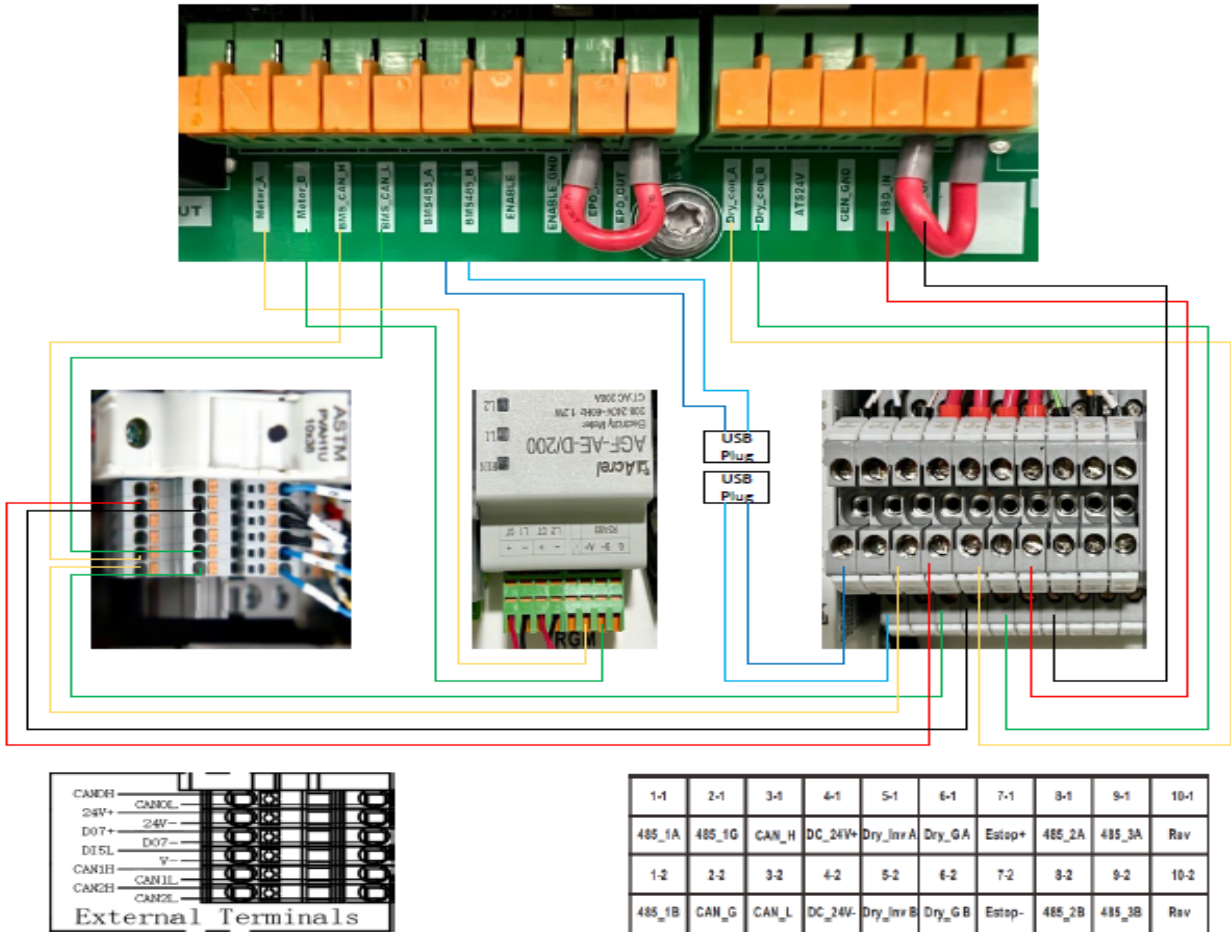

Figure 5.7 SEP Low Voltage and Communication Wiring

SEP	Hybrid Inverter	Battery BMS	Note
RS485 A+	Meter_A		
RS485 B-	Meter_B		
485_1A	USB Adapter		
485_1B	USB Adapter		
CAN_H		CAN2H	
CAN_L		CAN2L	
DC_IN+		24V+	
DC_IN-		24V-	
Dry_IN+	Dry_con_A		
Dry_IN-	Dry_con_B		
Estop+	RSD_IN		
Estop-	RSD_OUT		
	BMS_CAN_H	CAN1H	
	BMS_CAN_L	CAN1L	

Table 5.2 SEP Low Voltage and Communication Terminal Map

5.1.7.2. SEP to Inverter RSD Connection

To ensure system components are under proper control when E-stop is enabled, SEP E-Stop switch is physically tied to inverter RSD control. Please refer to Figure 5.7 and Table 5.2 for wiring detail.

5.1.7.3. SEP AC Cable Wiring

The SEP has two AC connections: (1) to the grid service, and (2) to backup service. When grid power is lost, the grid-side connection stops supplying power, the backup side connection stays energized if there is enough PV and/or battery power to support the loads.

5.1.7.4. System Grounding

For the Avalon ESS to work properly and provide accurate fault detection and protection, a common ground point and proper wiring is essential. The central grounding point of the system is the SEP ground bar, tie all other devices and components ground to this point.

- Grid GND to SEP ground bar.
- Hybrid Inverter GND to SEP ground bar.
- Battery GND to SEP ground bar.
- Load panel GND to SEP ground bar.

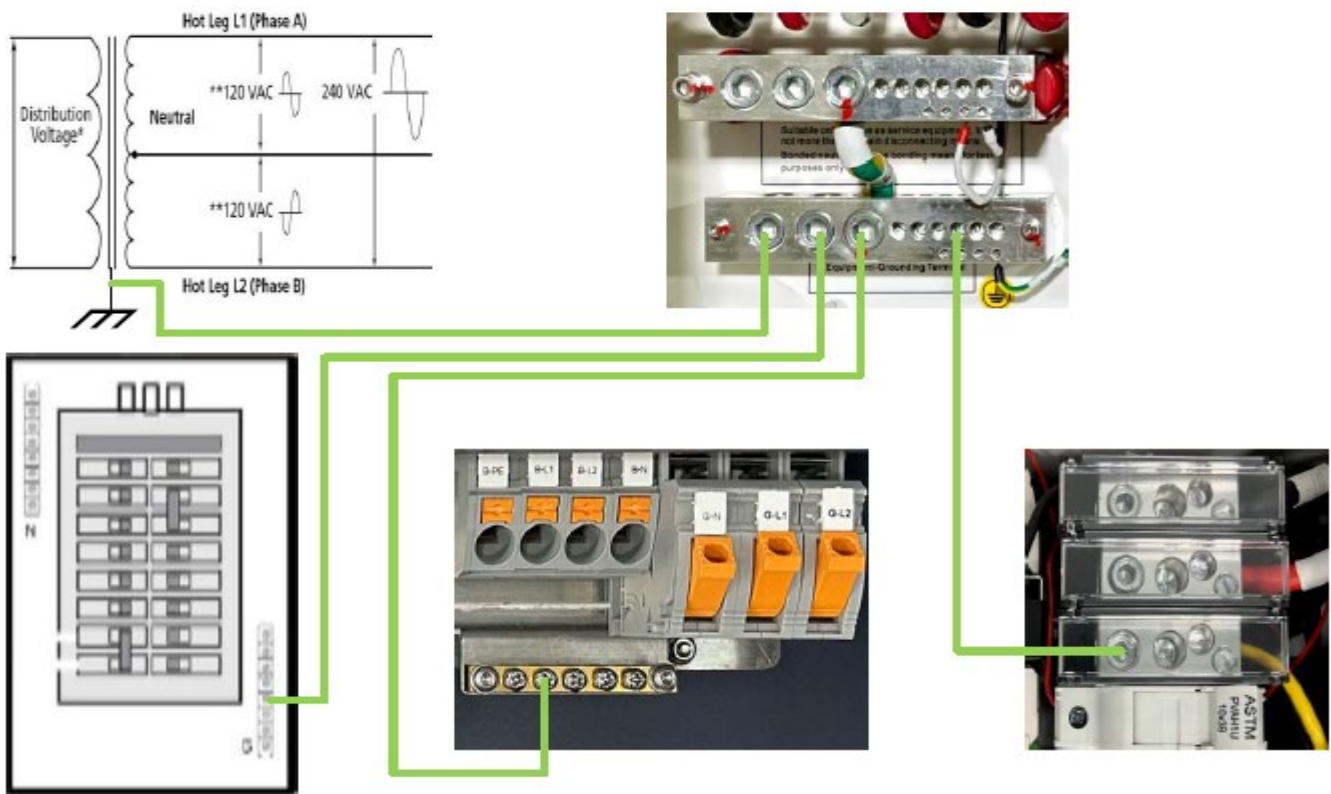

Figure 5.8 Avalon ESS Grounding

5.1.7.5. SEP to Grid AC Wiring

Land grid side AC wires from the Grid Meter or OCPD in the main service panel to SEP QF1 L1 and L2 terminals. Wire grid side neutral and PE wires to SEP neutral busbar and PE busbar, respectively.

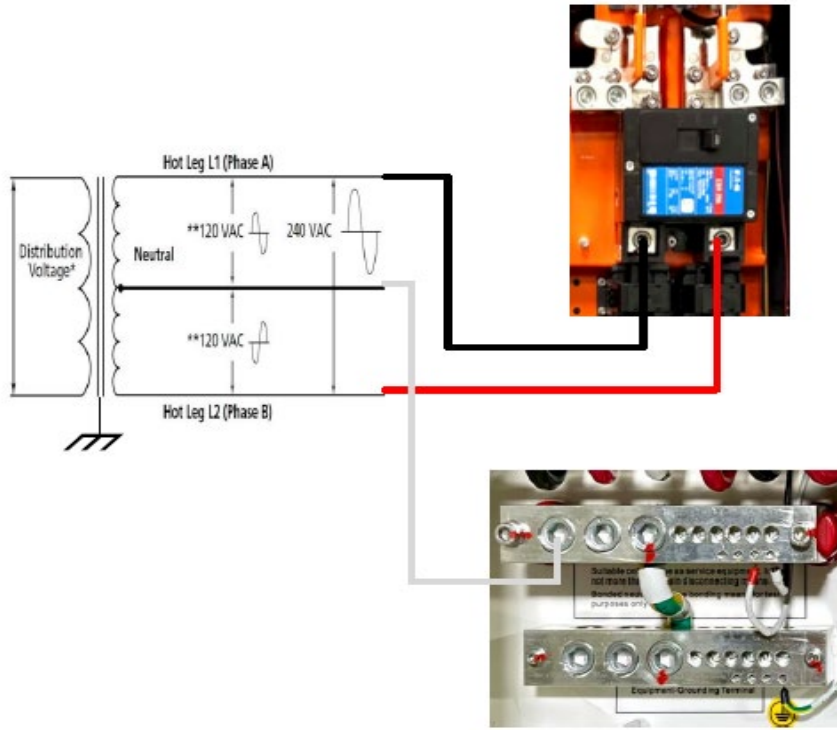

Figure 5.9 SEP Grid AC Wiring



DANGER:

Before installing the AC cables, be sure that the AC breakers are turned off. Use a multimeter to verify that the AC voltages are 0Vac before proceeding.

5.1.7.6. SEP to Inverter AC Wiring

Connect SEP Inverter Grid L1, L2 terminals to Hybrid Inverter G-L1, G-L2 terminals, respectively; connect SEP Inverter Backup L1, L2 terminals to Hybrid Inverter B-L1, G-L2 terminals, respectively; connect Inverter G-N, B-N terminals to SEP neutral busbar; and make sure Inverter PE is properly terminated on SEP PE busbar.

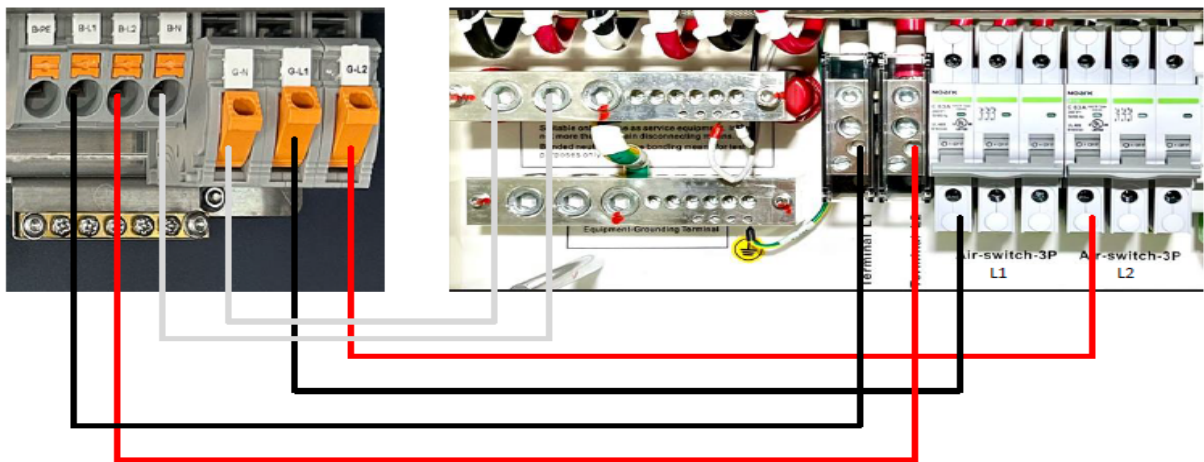

Figure 5.10 SEP to Inverter AC Wiring

Hybrid Inverter	SEP	Note
B-PE	PE	Protective Earth terminal
B-L1	Terminal L1	Inverter Backup port L1
B-L2	Terminal L2	Inverter Backup port L2
B-N	Neutral	Neutral terminal
G-N	Neutral	Neutral terminal
G-L1	Inverter Grid L1	Inverter Grid port L1
G-L2	Inverter Grid L1	Inverter Grid port L2

Table 5.3 SEP Inverter AC Terminal Map



DANGER:

Before installing the inverter cables, be sure that the inverter is powered off. Use a multimeter to verify that the cable voltages are 0V before proceeding.

5.1.7.7. SEP to Load AC Wiring

Disconnect desired load cable from the original circuit breaker, wire the breaker load end to SEP load control relay IN terminal, wire the original load cable to the same SEP load control relay OUT terminal. One SEP load control relay can handle one split phase 120V hot wire. To control a 240V two hot wires load, use an adjacent pair of SEP load control relays together. Make sure original panel neutral and PE busbar are properly terminated on SEP neutral and PE busbars.

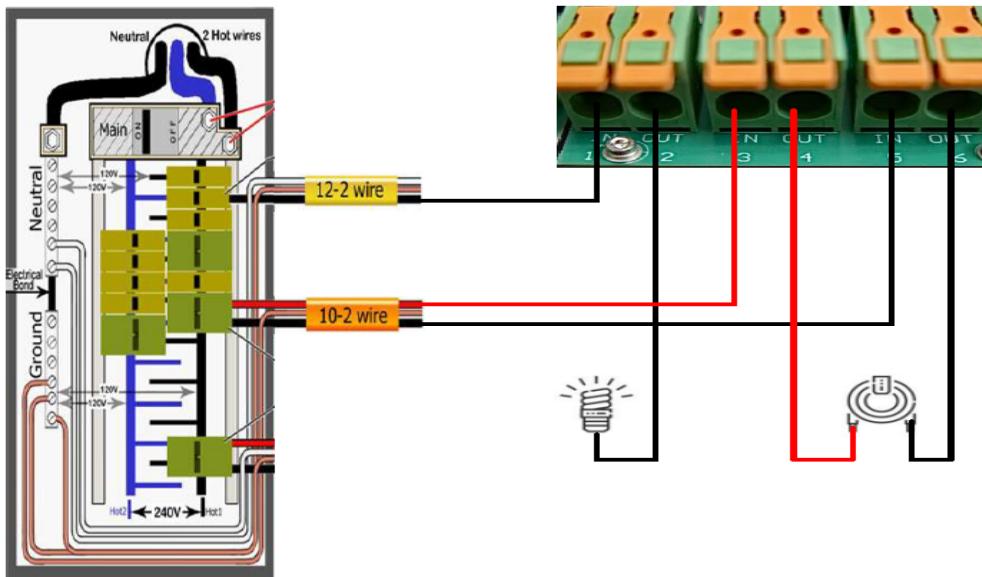

Figure 5.10 SEP to Load AC Wiring

To insert load cable into the control relay terminals, first lift up the orange knob and stop at 1st click (about 70 degrees from its vertical closed position). Do not attempt to lift the knob over 90 degrees, this will prevent the knob from closing back down, using excess force to close from this position may damage the knob. If the knob does get into the over-lift position (2nd click), it requires using a screwdriver to push out metal spring latch to re-position the knob and close. Figure 4.14 shows the correct operation and how to return the over-lift knob to normal position.

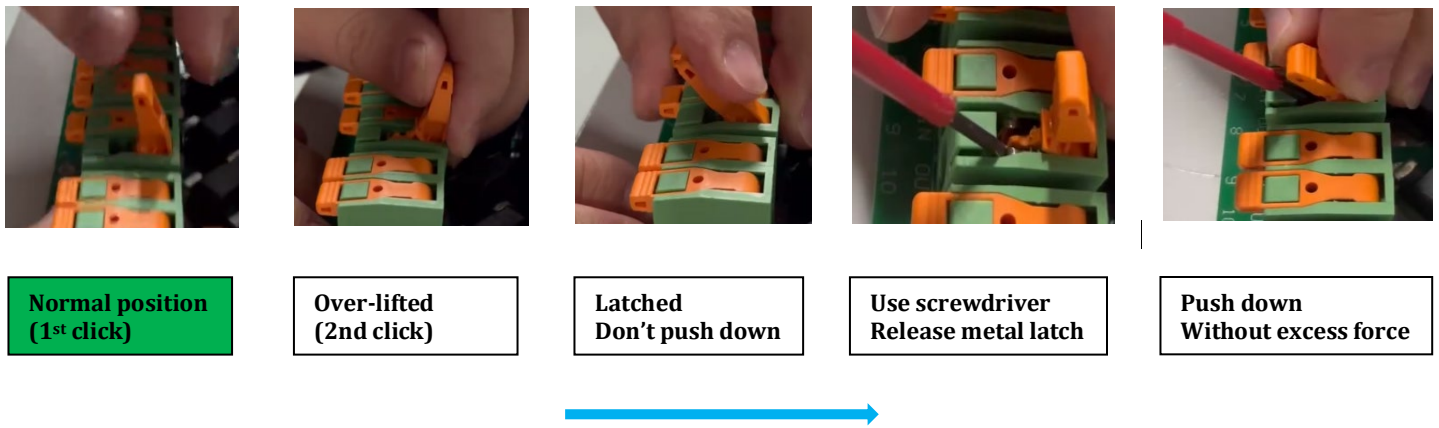

Figure 5.11 Load Relay Wiring Terminal Operation



DANGER:

Before wiring the load cables, be sure that the AC breakers are turned off. Use a multimeter to verify that the AC voltages are 0Vac before proceeding.

5.1.7.8. Communication Gateway Antenna and Network Cable

SEP has a built-in communication gateway, which supports Bluetooth communication for local commissioning and monitoring using FP Mobile App. The gateway also supports WiFi communication to home router, then to internet, where the Avalon ESS can be registered on FP cloud platform. When registered, FP customer service can support Avalon ESS remotely, including performing remote software upgrades, changing system settings, reviewing system alarms, and performing remote troubleshooting. The internal gateway is backed up by the Avalon Battery Pack, as long as battery stays operational, remote access to the ESS is possible.

The included external antenna must be installed for the wireless communication to function properly. Locate the SMA antenna connector at the bottom side of SEP, screw in the antenna tightly.

If WiFi signal is not available or troublesome, a wired network connection option to the SEP gateway is also provided. A RJ45 ethernet cable can be inserted through the communication knockout at the bottom of the SEP and terminate onto the network access port to the right of SEP communication terminal block.

5.2. Install HV Hybrid Inverter

5.2.1. Hybrid Inverter Overview

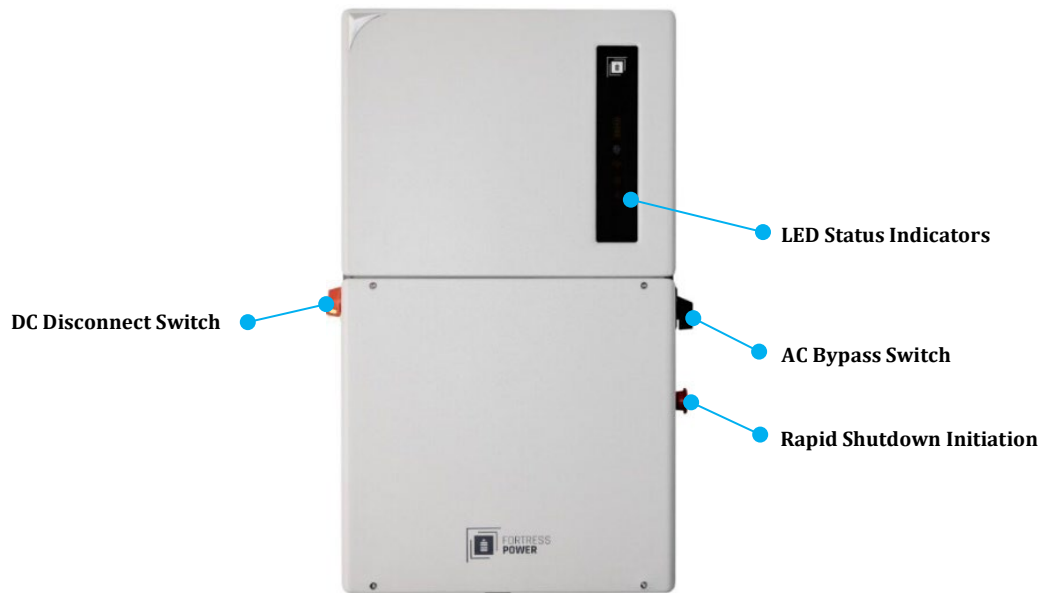

Figure 5.12 Hybrid Inverter Front View

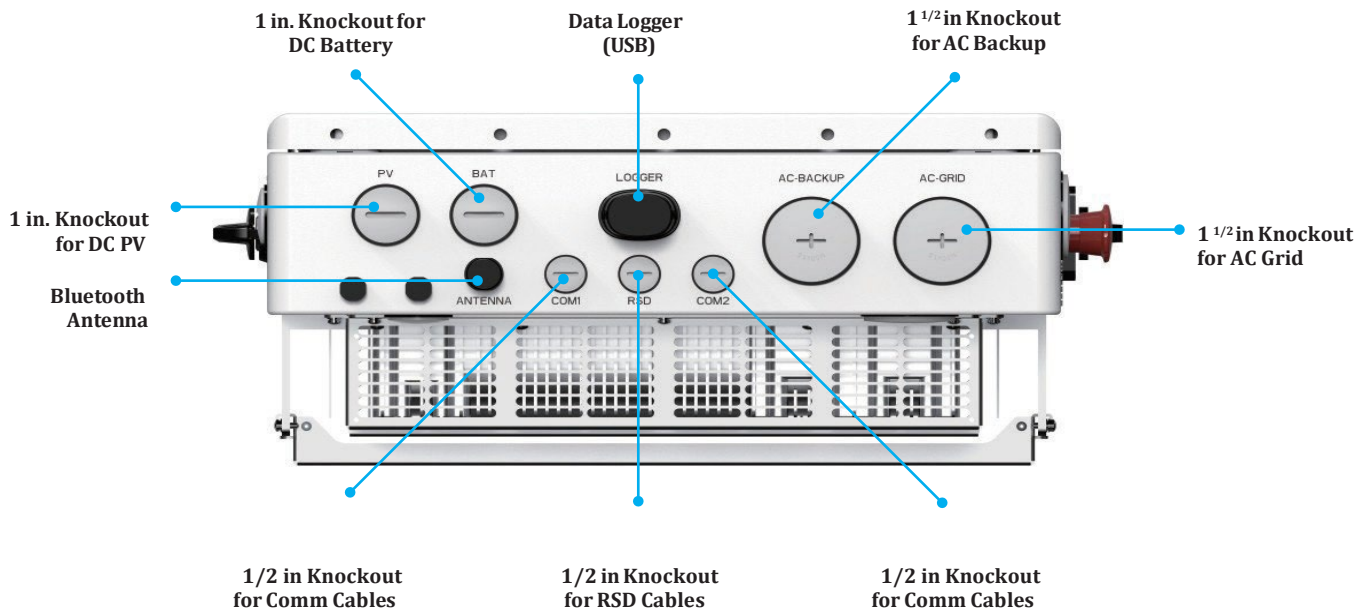

Figure 5.13 Hybrid Inverter Bottom View

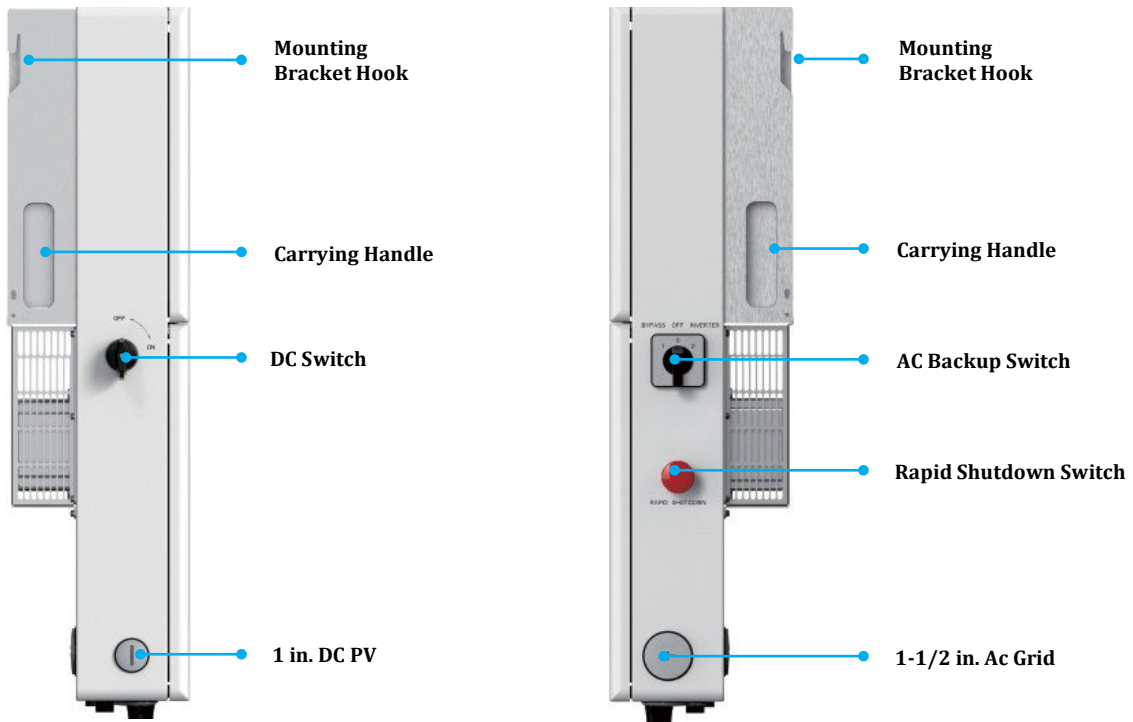

Figure 5.14 Hybrid Inverter Left/Right Side View

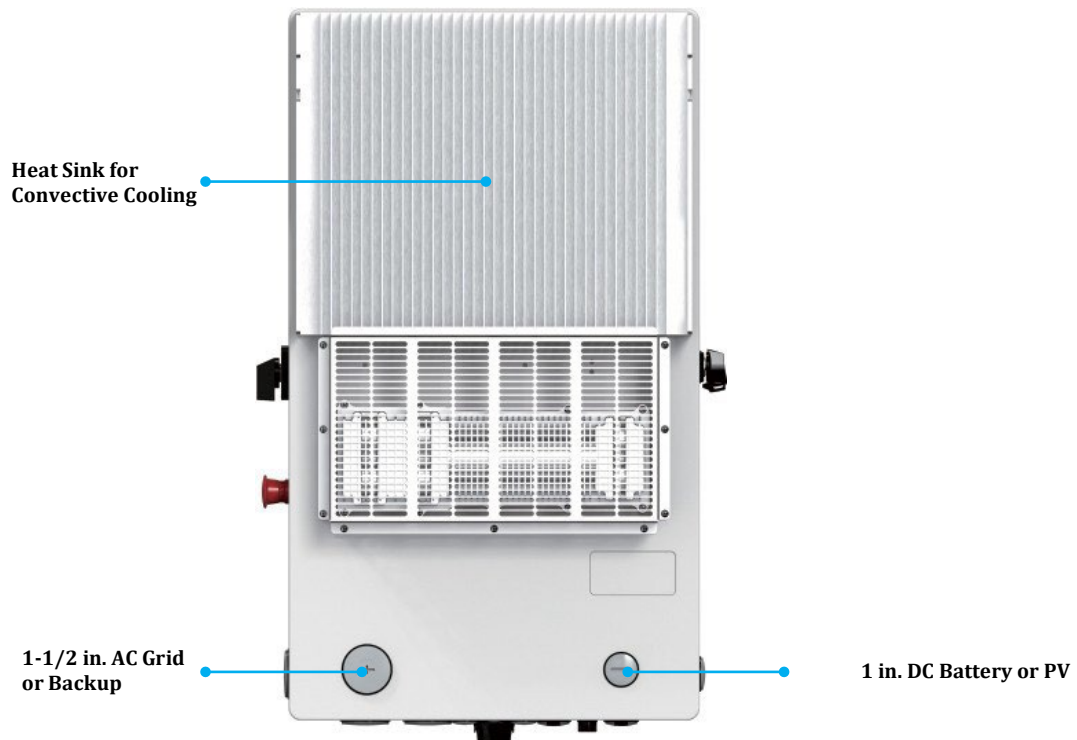

Figure 5.15 Hybrid Inverter Back View

5.2.2. LED Indicator Lights

There are five indicator lights on the Avalon HV Hybrid series inverter: Battery, Inverter, Wi-Fi, RS485 and Bluetooth. These lights indicate the working status of the inverter.



Light	Status	Description
 Battery	Blue Flashing every 3s	Battery is discharging
	Blue Flashing every 1.5s	Battery is charging
	Blue Solid ON	Battery is idle
	Yellow Solid ON	Battery has an alarm
 Inverter	Blue Solid ON	Inverter is operating normally
	Yellow Solid ON	Inverter has a warning alarm
	Red Solid ON	Inverter has a critical alarm
 Wi-Fi	Blue Solid ON	Reserved
	OFF	Reserved
 RS485	Blue Solid ON	The RS485 port is being used
	OFF	The RS485 port is not being used
 Bluetooth	Blue Solid ON	Reserved
	OFF	Reserved



Turning On the LED Indicator Lights

After a few minutes, the LED indicator lights will turn off to conserve power. To turn the lights back on, short-press the Inverter LED light.

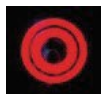

Alarm State

When the inverter has an alarm, the Inverter LED light turns red and starts flashing. It is recommended to connect to the inverter with the Bluetooth tool. Then you can determine what the alarm code is.



NOTE:

Battery/Wi-Fi/RS485/Bluetooth indicators will automatically turn off after 1 minute. The Inverter indicator will remain on with lower brightness. Short press the Inverter indicator to wake up the other indicators.

5.2.3. Install Wall Mount Bracket and Hang Inverter

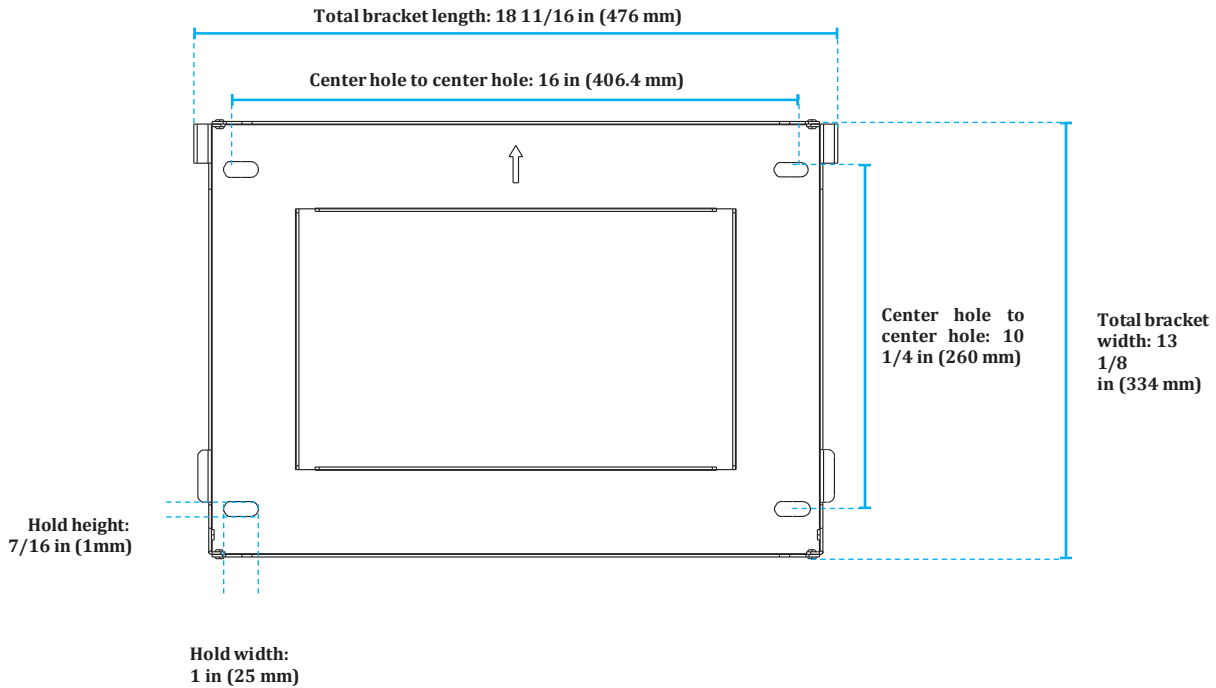

Figure 5.16 Inverter bracket dimensions

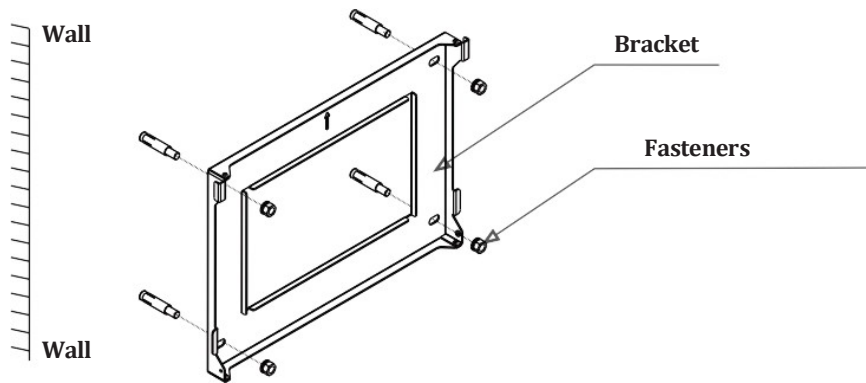

Figure 5.17 Fixing the bracket to the wall

- Place the bracket on the wall and use a bubble level to make sure it is level. The arrow in the middle of the bracket points up. With a pencil or marker, mark the mounting holes. Use a drill to prepare the holes for fasteners. Fasten the bracket to the wall.
- Lift up the inverter and align the back two hooks on the heat sink with the two tabs on the inverter mounting bracket.
- Lower the inverter hooks down onto the mounting bracket tabs and ensure the hooks have a solid bite before releasing the inverter.
- Then install the two set screws that are included with the inverter for stabilization. (see Figure 5.18)

NOTE:

The inverter must be mounted vertically at a 90° angle. Four fasteners must be used to ensure the bracket does not come off the wall. At least two must embed in a wall stud to bear the inverter weight.



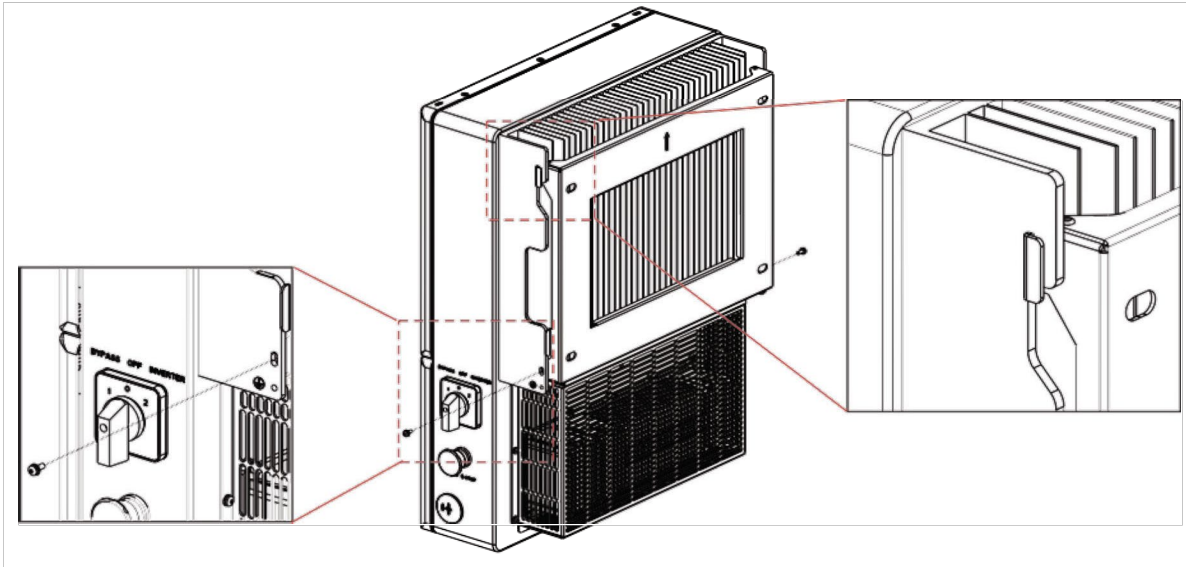

Figure 5.18 Inverter on mounting bracket and set screws



WARNING:

The inverter is very heavy. Please use proper lifting techniques to avoid potential injury. It is recommended that two people lift the inverter.

5.2.4. Hybrid Inverter Wiring Guide

Hybrid Inverter should use the wiring method in accordance with the NEC code. The auxiliary materials used for the sheath tube shall meet the requirements of UL514B.

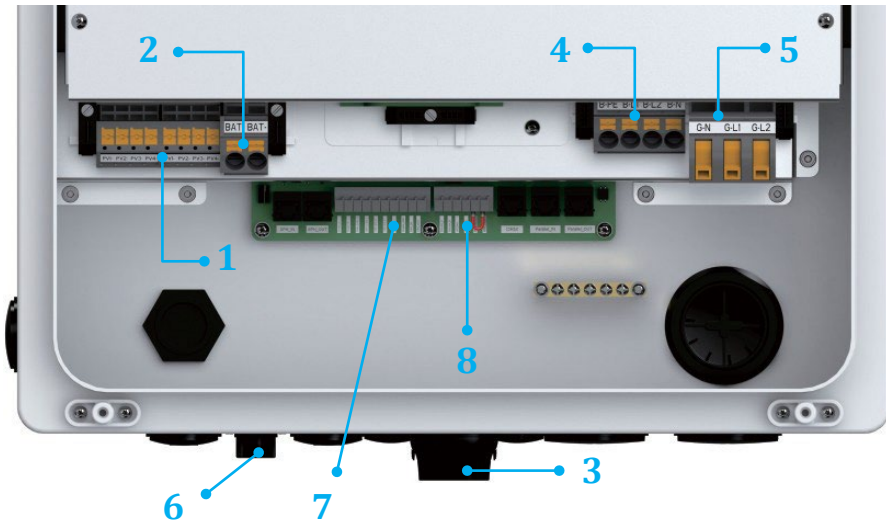

Figure 5.19 Hybrid Inverter Wiring Points

Point	Name	Description
1	PV	Knockout for PV conductors and PV terminals
2	Battery	Knockout for battery conductors and battery terminals
3	Logger	Reserved
4	AC-Backup	Knockout for AC conductors to backup and backup AC terminals
5	AC-Grid	Knockout for AC conductors to SEP and grid AC terminals
6	Bluetooth Antenna	Reserved
7	COM1/COM2	Knockouts for RS 485 and CAN communication cables and communication terminals
8	External RSD	Knockout for external RSD switch wiring and RSD terminals

Wire Name	Purpose	Making Connection	Wire Gauge Guide
PV Cables (Customer supply)	PV DC connection to the inverter	From the PV array to the DC+ and DC- terminals in the inverter	6AWG
Battery Cables (Customer supply)	Battery DC connection to the inverter	From the battery (+) and (-) terminals to the inverter BAT+ and BAT- terminals	4 or 6AWG
AC Grid Cables (Customer supply)	Inverter AC connection to the SEP	From the OCPD in the SEP to the AC-GRID L1 and L2 terminals	6AWG
AC Backup Cables (Customer supply)	Inverter AC connection to the backup subpanel	From the backup subpanel OCPD to the inverter AC-BACKUP L1 and L2 terminals	6AWG
Ground Cables (Customer supply)	Grounding conductors for the system	From the SEP ground bar to the ground bar inside the inverter wire box	6AWG
Meter RS485 Cable (Included in BMS package)	Communication between inverter & meter	From meter to terminal Meter_A and Meter_B. For more details, refer to Battery installation guide.	22-16AWG

Battery CAN Cable (Included in BMS package)	Communication between the inverter & the battery	From battery to terminal CAN-L and CAN-H. For more details, refer to Battery installation guide	22-16 AWG
---	--	---	-----------

Table 5.1 Inverter Wiring Guideline

5.2.5. Hybrid Inverter Wiring Instructions

5.2.5.1. Hybrid Inverter External Grounding

An optional external ground connection point is available on the right side of the inverter. The internal ground bar is grounded to the inverter chassis.

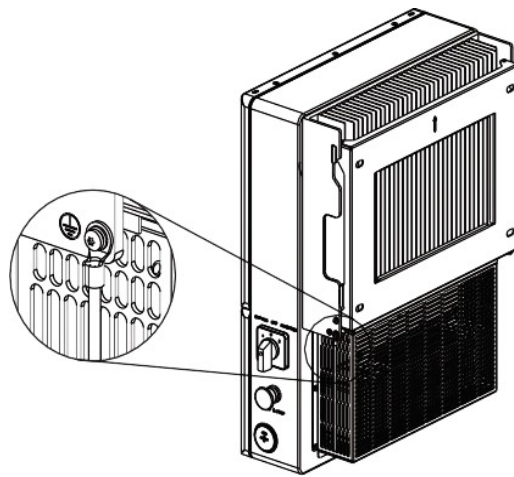

Figure 5.20 External Grounding Conductor Terminal Location



NOTE:

For multiple inverters in parallel, all inverters should be connected to the same ground point to eliminate the possibility of a voltage potential existing between inverter grounds.

To connect the grounding terminal on the heat sink, please follow the steps below:

- It is recommended to use copper wire for the chassis ground. Either solid conductor or stranded wire is acceptable. Refer to local code standard for wire sizing.
- Strip ½ inch of insulation off the end of the ground cable (see Figure 5.21)
- Crimp a ring terminal onto the ground cable with a ratcheting crimp tool.
- Connect the cable to the ground terminal screw and then tighten it with a torque wrench screwdriver to 2N.m.

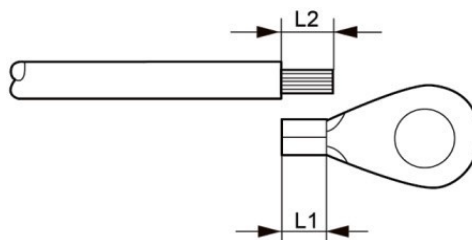

Figure 5.21 External Grounding Conductor Ring Terminal

5.2.5.2. PV Cable Installation



DANGER:

Before installing the PV cables, be sure that the PV array is disconnected. Use a multimeter to verify that the PV string voltages are 0V before proceeding. If rapid shutdown is being used, then under 30Vdc per string is safe.

Please verify the following before connecting the PV strings to the inverter:

- Ensure the DC voltage of the PV strings will not exceed the maximum DC input voltage (600Vdc). Violating this condition will void the inverter warranty.
- Ensure the polarity of the PV strings are correct (ex: positive is positive).
- Ensure the DC-switch, battery, AC-BACKUP, and AC-Grid AC breakers are all off. Ensure the PV resistance to ground is higher than 20K ohms.
- Ensure that the Isc of the strings will not exceed the maximum DC input current.

Note: Each PV string input is a separate MPPT

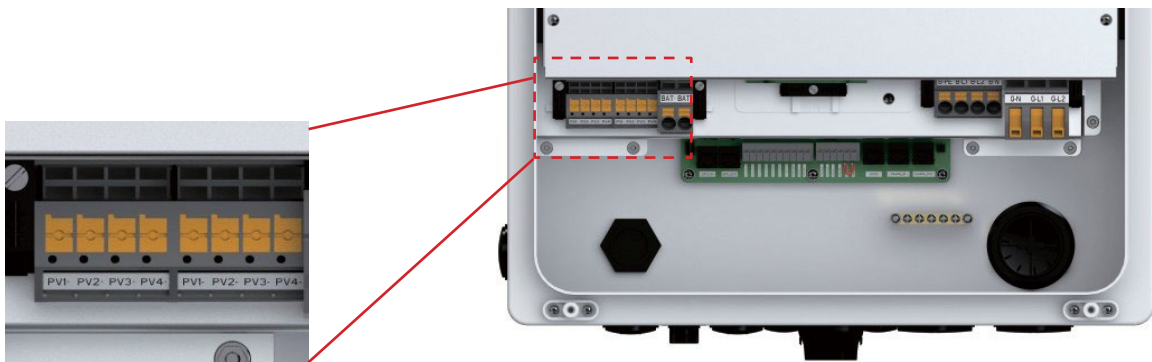

Figure 5.22 PV Cable Connection

1. Strip ½ inch of sheath off the ends of each PV cable.
2. Insert a flat head screwdriver into the slot of the orange square above the terminal.
3. Push in with the screwdriver, the terminal will open.
4. Insert the PV cable into the terminal.
5. Release the screwdriver and the terminal will clamp down on the PV wire.
6. Give the PV wire a gentle tug test to ensure that the connection is tight.
7. If the connection feels loose, repeat steps 1-5 again.

CAUTION:



If the DC conductors are accidentally connected in reverse or if the inverter is not working properly, do NOT turn off the DC switch. Otherwise, it may cause a DC arc and damage the inverter or catch fire.

The steps for corrective actions are as follows:

- Use a DC amp clamp multimeter to measure the DC string current.
- If the current is above 0.5A, please wait for the irradiance on the PV array to diminish until the current drops below 0.5A.

5.2.5.3. Internal Rapid Shutdown



IMPORTANT NOTE:

The inverter comes with an internal rapid shutdown transmitter. This transmitter brand must match the receivers that are being installed with the PV modules. **Not abiding by this will void the inverter warranty.**

How the inverter achieves module-level rapid shutdown:

The internal transmitter generates a PLC signal when it receives AC power. This signal travels up the PV strings to the receivers that are connected to the PV modules. When the receivers get this signal, they turn on PV output and allow the string voltage to ramp up. When the receivers lose this signal, they turn off PV output and ramp down each PV module to output around 0.6Vdc.

The red “Rapid Shutdown” switch disables the internal transmitter.

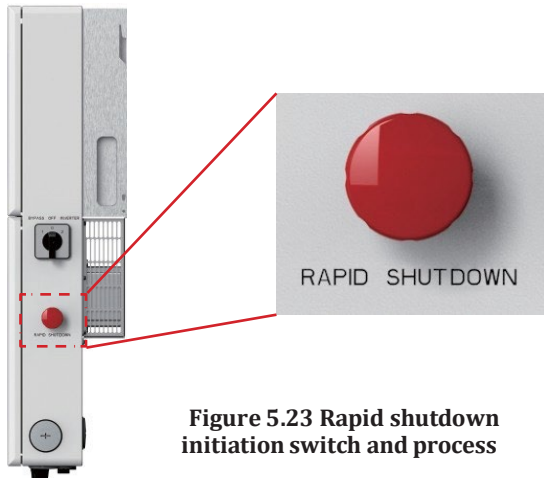

Figure 5.23 Rapid shutdown initiation switch and process

The Rapid Shutdown Initiation Process

1. Press the switch button in to turn off the internal transmitter. This will initiate rapid shutdown of the PV (ramps the PV voltage down)
2. Twist the switch clockwise to turn the transmitter back on. This will bring the PV voltage back up to normal.

Note:

Rapid shutdown will only initiate if receivers have been installed on the PV modules. Without the receivers, rapid shutdown is not possible.

Additional Details About Rapid Shutdown

1. With rapid shutdown receivers installed, the PV string voltages should be very low. Depending on the receiver type, it
2. should be measured between 0.6 and 0.7Vdc per module. Example: x10 modules = 6V-7V for the whole string.
3. If the PV string voltages are low, check that the AC breaker is turned on so that the inverter is getting AC voltage, and that the rapid shutdown switch is popped out. Give the switch a twist clockwise to verify it has popped out.
4. The DC switch does not have to be turned on for the receivers to receive the PLC signal from the internal transmitter. However, if an external DC switch is installed, ensure that it is turned on or else the receivers will not be able to get the PLC signal from the transmitter.

5.2.5.4. External Rapid Shutdown

If the inverter is being installed where it is inaccessible to first responders, an external rapid shutdown switch must be installed somewhere it is accessible.

Option 1 - Installing an External Rapid Shutdown Initiation Switch

1. Install the external RSD switch and run two wires between it and the inverter.
2. Remove the red jumper from the RSD_IN and RSD_OUT terminals (see Figure 5.24)
3. Connect one end of the two wires to the RSD_IN and RSD_OUT terminals.
4. Connect the other end of the two wires to the external RSD switch.

Note: the RSD switch on the inverter wire box will still initiate rapid shutdown. Be sure the transmitter is on by giving the switch a clockwise twist when you are ready to energize the system.

Please contact your local supplier for an external rapid shutdown switch.

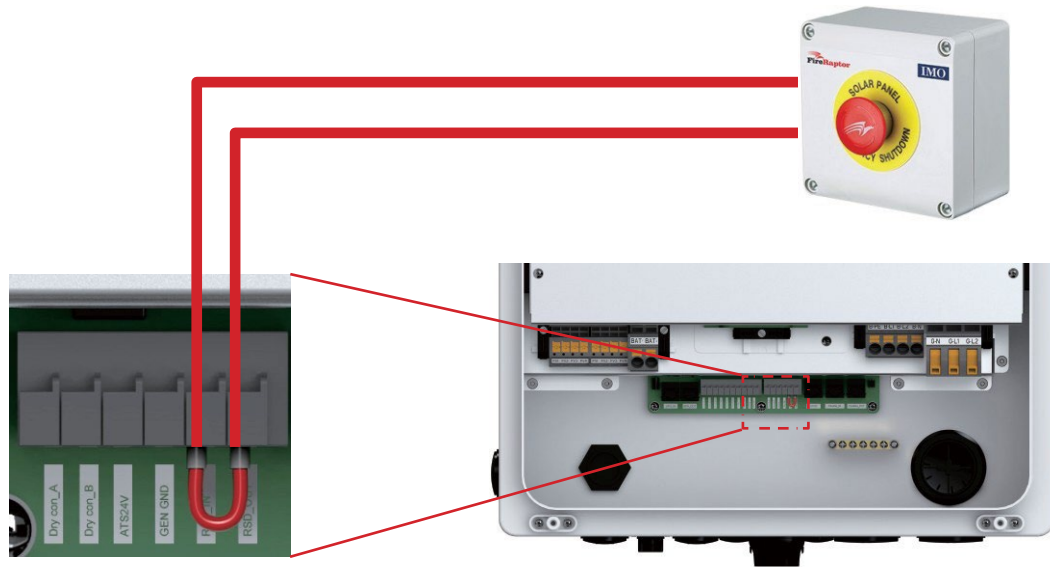

Figure 5.24 External RSD Initiation Switch

External Rapid Shutdown Transmitter Guidance

An external transmitter can be installed, but the internal transmitter must be disabled so there is no crosstalk between the two transmitters.

1. Disable the internal transmitter by removing the red jumper (see Figure 5.24)
2. Install the external rapid shutdown transmitter in accordance with the transmitter user manual.
3. For the PV to generate power in backup mode, the external transmitter must get power from the inverter backup circuit. You can also take the 12Vdc from the internal transmitter.

Note: the red jumper completes the 12Vdc circuit by closing the positive + side.
Please consult the RSD user manuals when installing the RSD components.

Option 2 – Connect to Avalon Smart Energy Panel

Avalone Smart Energy Panel can initiate the RSD function by switching the E-Stop function.

1. Run two wires from SEP communication terminal Estop+/Estop- into the inverter.
2. Remove the red jumper from the RSD_IN and RSD_OUT terminals (see Figure 5.24)
3. Terminate the 2 wires from SEP in step 1 to the RSD_IN and RSD_OUT terminals.
4. Please refer to Section 5.1.7.2. for Hybrid Inverter to SEP side wiring detail.

5.2.5.5. Communication Wiring

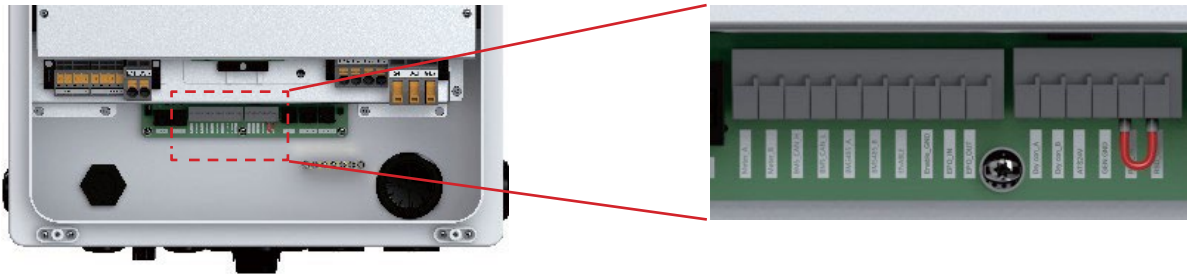

Figure 5.25 Hybrid Inverter communication terminals

The inverter communication terminal board consists of 16 wiring terminal ports, 5 RJ45 ports, and 1 antenna port. The table below shows the signal names of each port and its functionality.

NO.	Port Label	Function	Acceptable Wire Size Range	
1	Meter_A	485 communication terminals to electric meter in SEP	22-16 AWG	
2	Meter_B			
3	BMS_CAN_H	CAN communication terminals to battery BMS		
4	BMS_CAN_L			
5	BMS485_A	Reserved		
6	BMS485_B			
7	ENABLE			
8	Enable_GND			
9	EPO_IN	Emergency Power Off signal terminals to SEP emergency stop switch		
10	EPO_OUT			
11	Dry con_A	Grid on/off signaling terminals to SEP		
12	Dry con_B			
13	ATS24V	Reserved		
14	GEN GND			
15	RSD_IN	External rapid shutdown initiation switch terminals (optional)		
16	RSD_OUT			
17	Parallel IN	Parallel multiple inverter connection terminals (optional)		RJ45 Port
18	Parallel OUT			
19	DRM	Not Applicable		USB Port
20	LOGGER	Reserved		
21	COM1/COM2 & RSD	485 communication terminals to gateway in SEP		RJ45 Port
22	ANTENNA	Bluetooth signal extension port		

Steps for installing the communication wires:

1. The communication cables are supplied inside Avalon HV BMS Module package.
2. Wires are labeled to match inverter port labels.
3. Use a flat head screwdriver to lift the orange block on top of the terminal.
4. Insert the wire ferrule into the terminal.
5. Release the screwdriver and the terminal will clamp down on the wire.

6. Give the cable a gentle tug to ensure that it is firmly secured. If it is not, repeat steps 3-5.
7. Please refer to Section 5.1.7.1. for Hybrid Inverter to SEP and BMS side wiring detail.

5.2.5.6. Wiring Electric Meter

An electric meter must be installed to have a fully functional system. If the meter is not installed, key functions such as export power control and default energy storage modes will not be available.

1. The meter is wired into inverter using the communication cable in step 1 above.
2. Please refer to Section 5.1.7.1. for Hybrid Inverter to SEP side meter wiring detail.

5.2.5.7. Inverter Ground Wiring

For the Avalon system to work properly and provide accurate fault detection and protection, a common ground point and proper wiring is essential. The main ground point of the system is the SEP ground bar, inverter ground needs to be wired to SEP main ground bar. Please refer to Section 5.1.7.4. for the Avalon ESS grounding installation detail.

5.2.5.8. Battery Wiring



DANGER:

Before installing the battery cables, be sure that the battery is turned off. Use a multimeter to verify that the battery voltage is 0Vdc before proceeding. Consult the battery product manual for instructions on how to turn it off.

1. Strip ½ inch of sheath off the ends of each battery cable.
2. Insert a flat head screwdriver into the slot of the orange square above the terminal.
3. Push in with the screwdriver, the terminal will open.
4. Insert the battery wire into the terminal.
5. Release the screwdriver and the terminal will clamp down on the battery wire.
6. Give the battery wire a gentle tug test to ensure that the connection is tight.
7. If the connection feels loose, repeat steps 1-5 again.

Please refer to Section 5.3.11. for connection details on battery side.

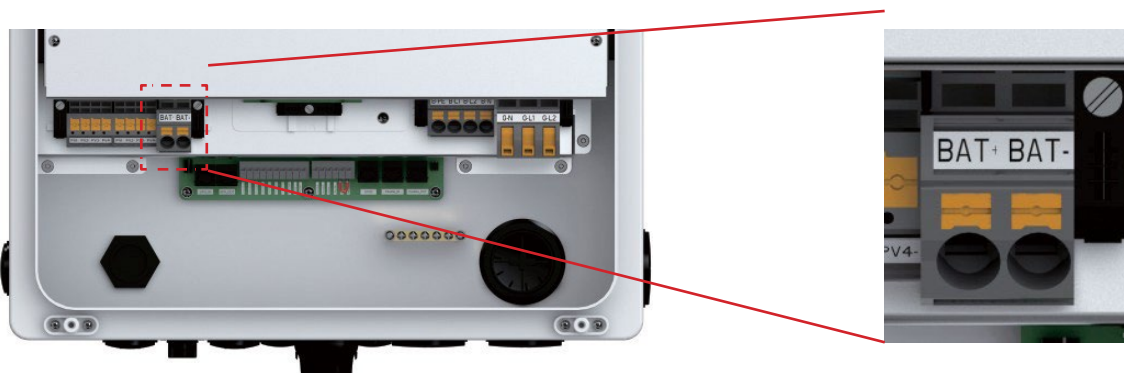

Figure 5.26 Battery Cable Connection



Additional Notes on Batteries:

For instructions on how to turn the battery on, please consult the <<Avalon HV Battery Installation Guide>> and be sure to wait until the system is fully installed before turning the battery on. This inverter only works with Avalon HV Battery models. For other battery's compatibility with Avalon HV Hybrid Inverter, please contact Fortress Power technical support for assistance.



NOTE:

The battery fuse in the inverter wire box is replaceable. The replacement can only be done by a technician authorized by Fortress Power. Fuse specification: 750V, 63A.



NOTE:

Before connecting the battery, please carefully read the product manual of the battery and perform the installation exactly as the battery manufacturer specifies.

5.2.5.9. AC Terminals

The inverter has two sets of AC terminals: (1) Backup terminals to SEP and (2) Grid terminals to SEP. When grid power is lost, the Grid-side of the inverter shuts off. The Backup-side of the inverter stays energized if there is enough PV and battery power to support the loads. The inverter can be connected to other Avalon hybrids inverters in parallel to provide additional support to the backup loads.

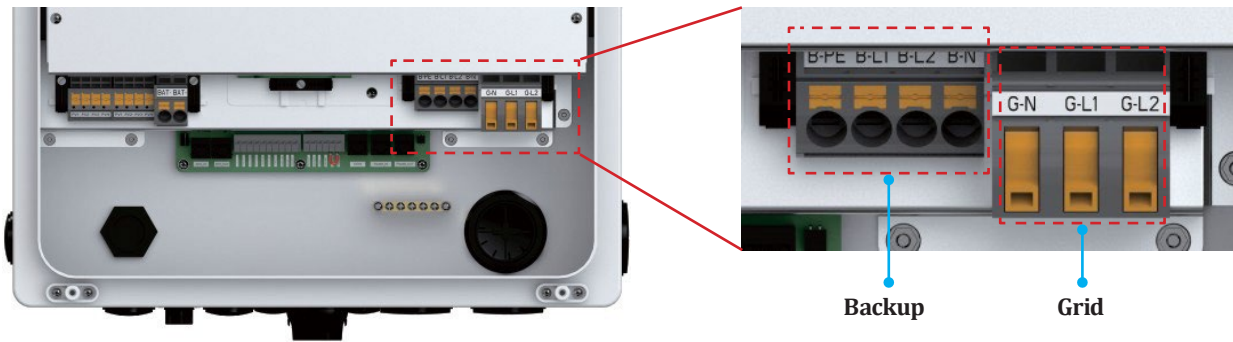

Figure 5.27 AC output terminals

Model	Avalon HV Hybrid PC76	Avalon HV Hybrid PC114
AC Grid Cable Max. Wire Size Accepted by Terminal	4 AWG	4 AWG
AC Backup Cable Cross Sectional Area	6 AWG	6 AWG

Table 5.2 AC Cable Size Limitations



Over-Current Protection Device for the AC Terminals

To protect the inverter against over-current and leakage, OCPD devices for both Grid and Backup ports are required and are designed into SEP. The Grid side breaker is supplied with matching inverter mode rating inside the inverter package and needs to be installed in SEP. Backup side breaker size is system specific and needs to be sourced by customer. Please refer to Table 4.1 for the breaker selection and installation detail.

5.2.5.10. AC Terminal Wiring



DANGER:

Before installing the AC cables, be sure that the AC breakers are turned off. Use a multimeter to verify that the AC voltages are 0Vac before proceeding.

To connect grid AC cables into the Grid terminals:

1. Strip ½ inch of sheath off the ends of each cable.
2. Insert a round head screwdriver fully into the orange round hole, pull up to open. The knob needs to go all-the-way to the top, or the 2nd click to fully open the wire terminal. (Figure 5.28)
3. Insert the grid AC wire into the terminal.
4. Pull down the knob completely to close the terminal once the AC wire is inside.
5. Give the AC wire a gentle tug test to ensure that the connection is tight.
6. If the connection feels loose, repeat steps 1-5 again.

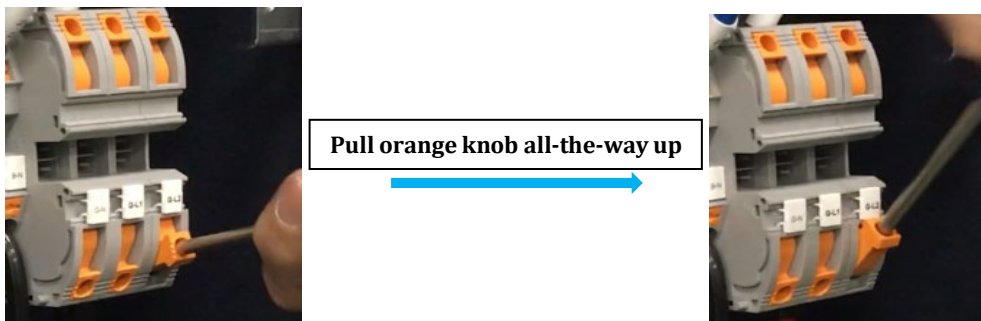

Figure 5.28 Grid AC Terminal Operation

To connect backup AC cables into the Backup terminals:

1. Strip ½ inch of sheath off the ends of each cable.
2. Insert a flat head screwdriver into the slot of the orange square above the terminal.
3. Push in with the screwdriver, the terminal will open.
4. Insert the backup AC wire into the terminal.
5. Release the screwdriver and the terminal will clamp down on the AC wire.
6. Give the AC wire a gentle tug test to ensure that the connection is tight.
7. If the connection feels loose, repeat steps 1-5 again.

Please refer to Section 5.1.7.6. for detailed connection steps on SEP side.

5.2.5.11. AC Backup Switch

This failsafe switch determines the power source of the inverter backup circuit. If the inverter fails or has a critical alarm, the backup circuit will shut off. Should this occur, the switch set to 1 allows power to pass through the inverter to the backup from the grid.

The three settings operate as follows:

- 1:** backup circuit is powered by the grid directly
- 0:** backup circuit is disconnected from the inverter
- 2:** backup circuit is powered by the inverter directly

For normal operation, the switch should be set to 2. On 2, if the grid fails the backup circuit will remain energized by the inverter with the available PV and battery power. The 0 setting is to turn off AC power to the backup circuit.



- 1** is for bypass (failure)
- 0** turns backup off
- 2** is for normal operation



Backup without PV and AC-Coupling:

A battery is required for backup power. If only PV is installed, this inverter is not able provide backup power when the grid is down. However, the inverter can support the backup panel with a battery only and no PV. The inverter with a battery can be AC-coupled to a system without directly connecting any PV to the inverter.

Depending on the battery, the Avalon hybrid inverter can provide 14.7kWh to 58.8kWh of stored power in backup mode or for time-of-use. It is recommended to determine how much average PV power will be available and what average power consumption is to understand how long the battery will last in the event of a grid outage. The battery discharge power can be limited to ensure the battery drains slowly. If the backup power demanded exceeds what is available, the inverter will display an alarm code and will shut down for a few minutes.

5.3. Install HV Battery Pack

5.3.1. HV Battery Pack Overview

Please note Avalon HV Battery Pack can only be utilized with Avalon HV Hybrid Inverter. Using a battery with a charging rate greater than the battery's maximum charging rate will trigger battery safety protection.

For other battery's compatibility with Avalon HV Hybrid Inverter, please contact Fortress Power technical support for assistance.

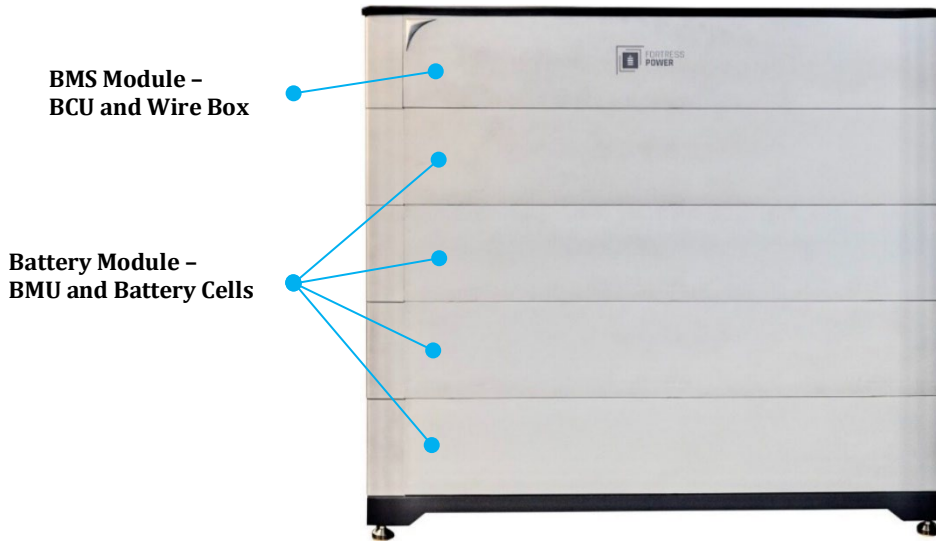

Figure 5.29 Battery Pack Front View (4 Battery Modules option shown)



Figure 5.30 Left Side View



Figure 5.31 Right Side View

5.3.2. BMS Module Indicator Light

The indicator light on the BMS Module control and wiring panel displays battery pack operation states. When the battery pack is operating normally, the indicator light is green. When the system fails, the indicator light is red. If the fault still exists after restarting, please contact Fortress Power technical support.

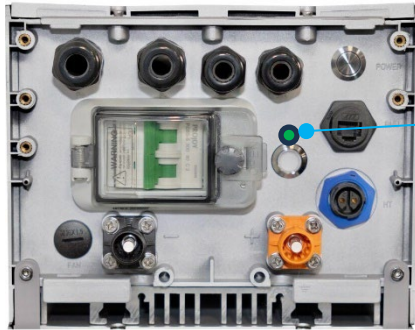

NOTE:

If the indicator light does not go on, make sure the breaker is at ON position and power button is pressed in to turn the battery system on.

Figure 5.32 System Status Indicator Light

5.3.3. BMS Module Control and Wiring Panel and Connection Points

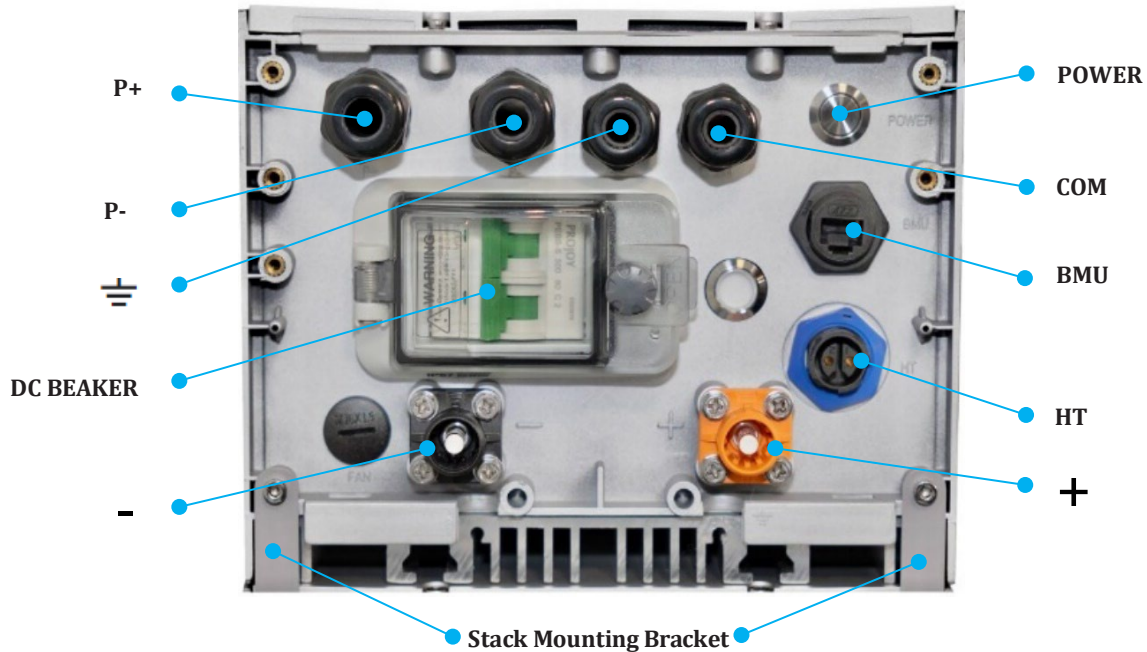



Figure 5.33 BMS Module Control and Wiring Panel

Label	Name	Specification	Function
1	POWER	Waterproof self-locking metal power on/off button	Switch system power ON and OFF
2	BREAKER	PEBS-S-500V80A/C/2 Breaker	Pack power output protection
3	P+	PG head/M20*1.5 extended type, nylon waterproof cable gland. Diameter range ϕ 6~12mm	Power cable external port. Positive
4	P-	PG head/M20*1.5 extended type, nylon waterproof cable gland. Diameter range ϕ 6~12mm	Power cable external port. Negative
5		PG head/M16*1.5 extended type, nylon waterproof cable gland. Diameter range ϕ 5~10mm	Grounding cable external port. PE
6	COM	PG head/M16*1.5 extended type, nylon waterproof cable gland. Diameter range ϕ 5~10mm	Comm cable external port. CAN/DC
7	BMU	LLT-RJ45-M19-0801MFZ21201/-25°C~105°C/IP67/Socket	Pack internal BMU communication
8	+	B-E57-S01-00-NM5/Orange/N key position/M5 threaded hole	Pack internal power terminal. Positive
9	-	B-E57-S01-00-AM5/Black/A key position/M5 threaded hole	Pack internal power terminal. Negative
10	HT	WZ10050028 M19/2 core waterproof socket	Pack internal heater terminal

5.3.4. Battery Module Wiring Panel and Connection Points



Figure 5.34 Battery Module Wiring Panel

Label	Name	Specification	Function
1	BMU IN	LLT-RJ45-M19-0801MFZ21201/-25°C~105°C/IP67/Socket	Module BMU input
2	BMU OUT	LLT-RJ45-M19-0801MFZ21201/-25°C~105°C/IP67/Socket	Module BMU output
3	+	B-E57-S01-00-NM5/Orange/N key position/M5 threaded hole	Module power terminal. Positive
4	-	B-E57-S01-00-AM5/Black/A key position/M5 threaded hole	Module power terminal. Negative
5	HT IN	WZ10050028 M19/2 core waterproof socket	Module heater input
6	HT OUT	WZ10050028 M19/2 core waterproof socket	Module heater output

5.3.5. Assemble and Mount Battery Pack

- Mount the battery on a flat floor against a stabilization wall structure.
- The battery pack must be mounted vertically.
- Adequate spacing around the BMS wire box, BMS control and wiring panel, and Battery module wiring panel must be provided to gain easy access for installation and maintenance.



WARNING:

The battery is very heavy. Please use proper lifting techniques to avoid potential injury. It is recommended that two people lift the battery.

1. Place the battery pack base 2.5 inches from the back wall, install and adjust the leveling bolts. Use a spirit level to level the base.

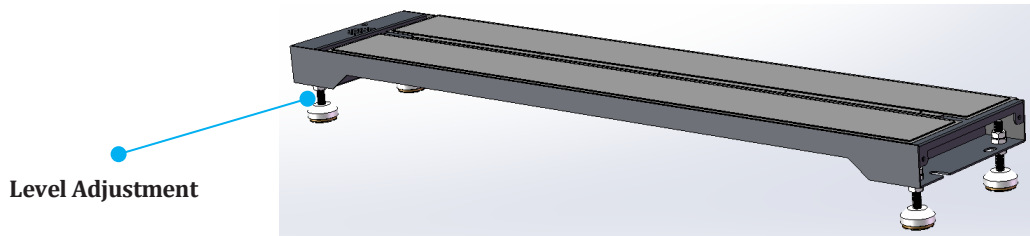

Figure 5.35 Battery Pack Base Assembly

2. Place the battery module flat on the pack base. On the left side, loosen the screws holding the stack mounting brackets, rotate 180 degrees, and fix the brackets on the left side of the base using the M4 screws. On the right side loosen the screws holding the stack mounting brackets, rotate 180 degrees, and fix the brackets on the right side of the base using the M4 screws. Then fixed the wall anchor brackets on both left and right side to secure battery module to the stabilization wall.

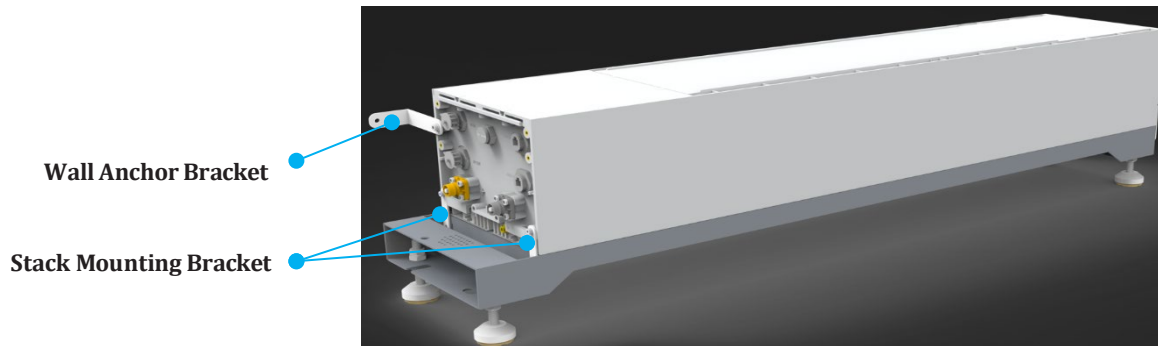

Figure 5.36 Mount Battery Module to Base

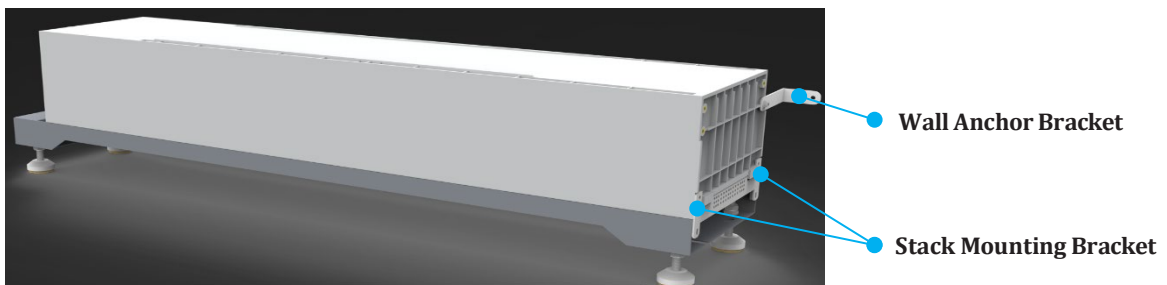

Figure 5.37 Stack Battery Module

3. Place 2nd battery module flat on the 1st battery module. On the left side, loosen the screws holding the stack mounting brackets, rotate 180 degrees, and fix the brackets on the left side of the 1st battery module using the M4 screws. On the right side loosen the screws holding the stack mounting brackets, rotate 180 degrees, and fix the brackets on the right side of the 1st battery module using the M4 screws. Then fixed the wall anchor brackets on both left and right side to secure battery module to the stabilization wall.
4. Repeat step 3 to stack additional battery modules one by one, fix stack mounting brackets and wall anchor brackets. Last, stack the BMS module at the top, fix stack mounting brackets and wall anchor brackets.

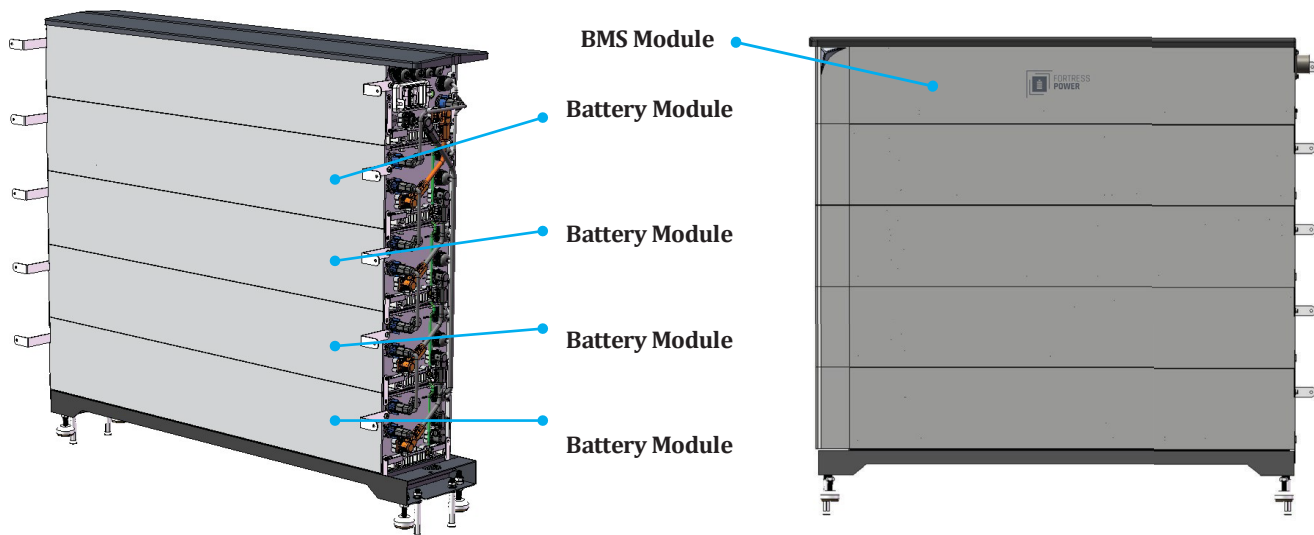

Figure 5.38 Stack Battery Modules and BMS Module

5.3.6. Battery Pack Internal Cabling and Pre-check

1. For battery module 1 to $N(≤6)$, connect the cable harness between the BMS module and all battery modules. Connect the GND cables first, then the BMU communication cables, followed by the heating cables, and finally the power cables.
2. Locate ground cable and M5 mounting screws from HV battery module connection kit, tie one end of the ground cable to “GND” hole on BMS module heat-sink with self-drilling screw, tie the other end of the ground cable to “GND” hole on the heat-sink of the battery module right below with self-drilling screw; repeat until reaching the battery module at the bottom of the rack.
3. Locate the BMU communication cable from HV battery module connection kit, connect BMS module “BMU” port to “BMU IN” port of the battery module right below; then connect current battery module “BMU OUT” port to “BMU IN” port of the battery module right below, until reaching the battery module at the bottom of the rack.
4. Locate heater cable from battery module connection kit, connect BMS module “HT” port to “HT IN” port of the battery module right below; then connect current battery module “HT OUT” port to “HT IN” port of the battery module right below, until reaching the battery module at the bottom of the rack.
5. Locate battery pack 9.5” positive cable from BMS Control Box connection kit, connect BMS module “+” port to “+” port of the battery module right below.
6. Then locate the battery module to module power cable with color-coded connectors from HV battery module connection kit, connect current battery module “-” port to “+” port of the battery module right below, match the connector color with terminal port color, until reaching the battery module at the bottom of the rack.
7. Last, locate battery pack 36” negative cable from BMS Control Box connection kit, connect the bottom battery module “-” port back to BMS module “-” port.
8. Switch on the DC breaker and press the Power button latching inward to “on” position, then check for the indicator light is green. After this preliminary check is OK, switch off the DC breaker and push the Power button to release outward to “off” position.

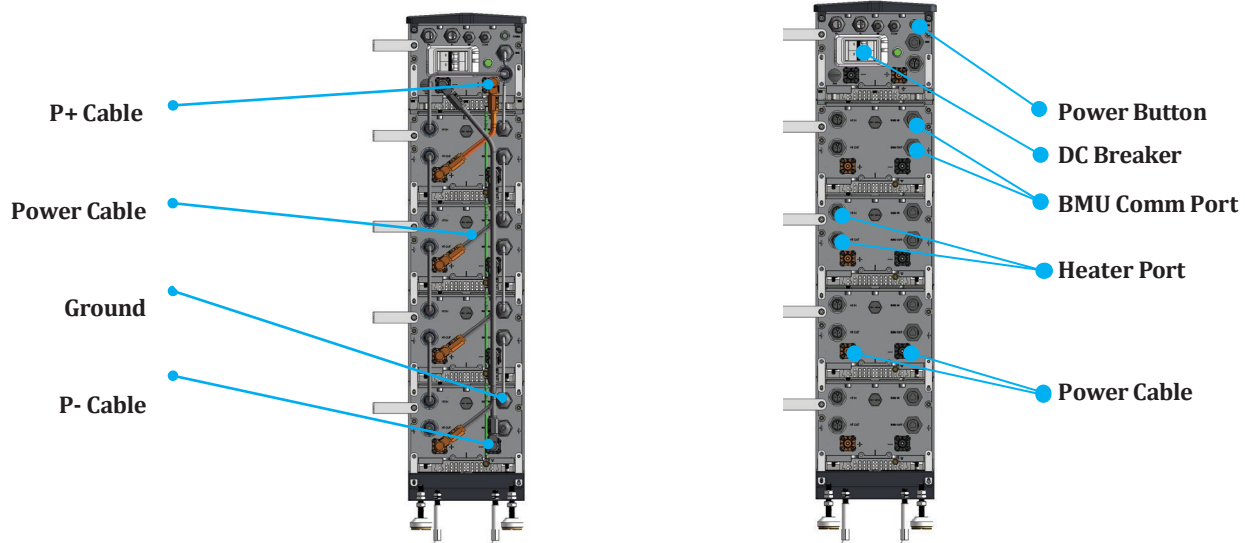

Figure 5.39 Battery Pack Cabling

5.3.7. Battery Pack External Wiring Overview

Wire Name	Purpose	Making Connection	Wire Gauge Guide
BMS to SEP Comm Cable (Supplied in BMS package)	Auxiliary 24V power supply and CAN communication to SEP	Match the supplied comm cable labels with connection points names on wiring chart, terminate wires on comm terminal block.	22-16AWG
BMS to Inverter Comm Cable (Supplied in BMS package)	CAN communication to PCS	Match the supplied comm cable labels with connection points names on wiring chart, terminate wires on comm terminal block.	22-16AWG
Power Cable (Customer supply)	Battery to Hybrid Inverter, charge, and discharge	From PCS Battery terminals to the DT+ and DT- terminals inside the BMS wire box	6AWG
Ground Cable (Customer supply)	Battery PE to main system PE in SEP	From the SEP ground bar to the ground bar inside the BMS wire box	6AWG

Table 5.3 Battery Pack External Wiring Guideline

5.3.8. External Wiring Preparation

1. Before performing external wiring connections, push battery Power on/off button to turn off battery, switch DC breaker to off position.
2. Open battery BMS module wire box cover, keep all locking screws for re-close the box cover.
3. Measure output voltage between “DT+/DT-” bus bars and make sure battery power output is 0V.
4. Battery BMS module package contains 3 communication cables for the Avalon ESS. They are labeled at bundle level and individual wire level. Identify the corresponding cable and run through the correct conduit paths.



DANGER:

Before installing the battery cables, be sure that the battery is turned off. Use a multimeter to verify that the battery voltage is 0Vdc before proceeding. Consult the battery product manual for instructions on how to turn it off.

5.3.9. Battery to Hybrid Inverter and SEP Communication Wiring

BMS	Hybrid Inverter	SEP	Note
CAN0H (Reserved)			
CAN0L (Reserved)			
24V+		DC_24V+	Auxiliary Power supply
24V-		DC_24V-	Auxiliary Power supply
D07+ (Reserved)			
D07- (Reserved)			
DI5L (Reserved)			
V- (Reserved)			
CAN1H	BMS_CAN_H		CAN communication
CAN1L	BMS_CAN_L		CAN communication
CAN2H		CAN_H	CAN communication
CAN2L		CAN_L	CAN communication

Table 5.4 Battery Pack to Hybrid Inverter and SEP Terminal Map

Follow the printed wiring chart inside BMS wire box cover, map the wire labels against the chart and insert the wire ferrules to the corresponding terminals of the terminal block. Check labels on both ends to make correct connections. A cross reference terminal map is given in Table 5.4 above.

Please refer to Section 5.1.7.1. for connection details on SEP and Hybrid Inverter side.

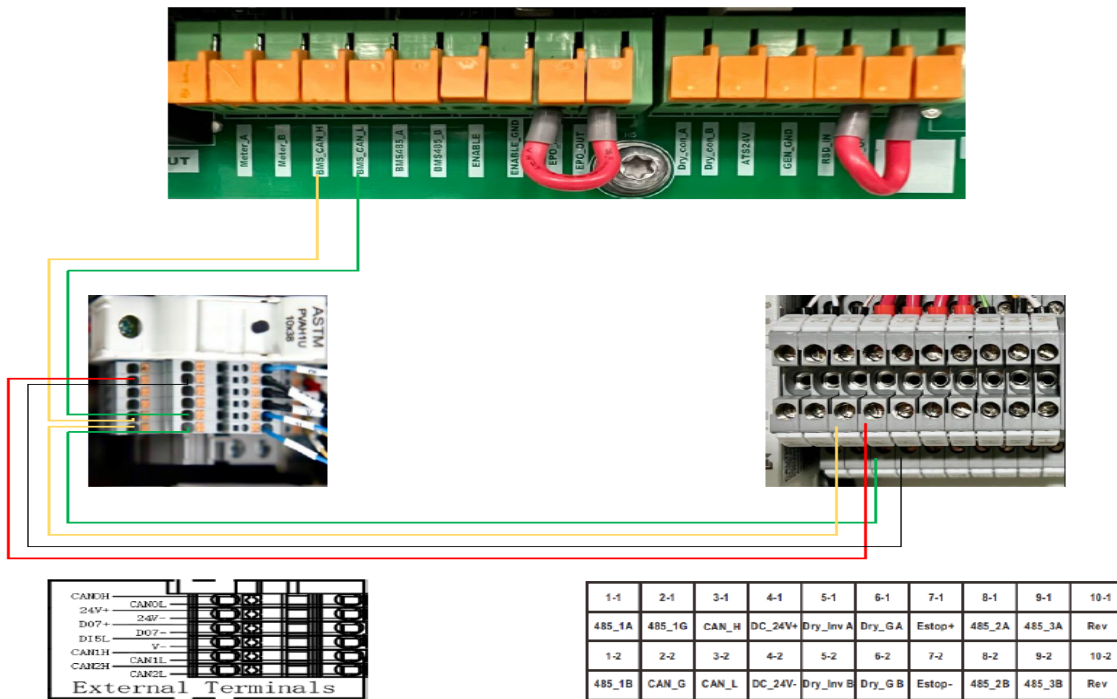

Figure 5.40 Battery Pack to Hybrid Inverter and SEP Communication Connection

5.3.10. Battery Pack Ground Wiring

For the Avalon system to work properly and provide accurate fault detection and protection, a common ground point and proper wiring is essential. The main ground point of the system is the SEP ground bar, battery ground needs to be wired to SEP main ground bar. Please refer to Section 5.1.7.4. for the Avalon ESS grounding installation detail.



IMPORTANT:

For multiple batteries in parallel, all batteries should be connected to the same ground point to eliminate the possibility of a voltage potential existing between battery grounds.

5.3.11. Battery to Inverter Power Cable Wiring

1. Strip ½ inch of sheath off the ends of each battery cable.
2. Use screwdriver to loosen a holding bolt on battery DT+/DT- busbar.
3. Insert the battery wire into the terminal hole.
4. Tighten the holding bolt.
5. Give the battery wire a gentle tug test to ensure that the connection is tight.
6. If the connection feels loose, repeat steps 1-5 again.

Please refer Section 5.2.5.8. for connection details on inverter side.



Figure 5.41 Battery Pack to Inverter Power Cable Connection

5.3.12. Battery Pack Final Assembly

1. Close the BMS module wire box cover and secure all locking screws.
2. Put all left covers of all battery modules and BMS module in bottom-up sequence.
3. And finally cover the waterproof top cover and fix it with locking screws.

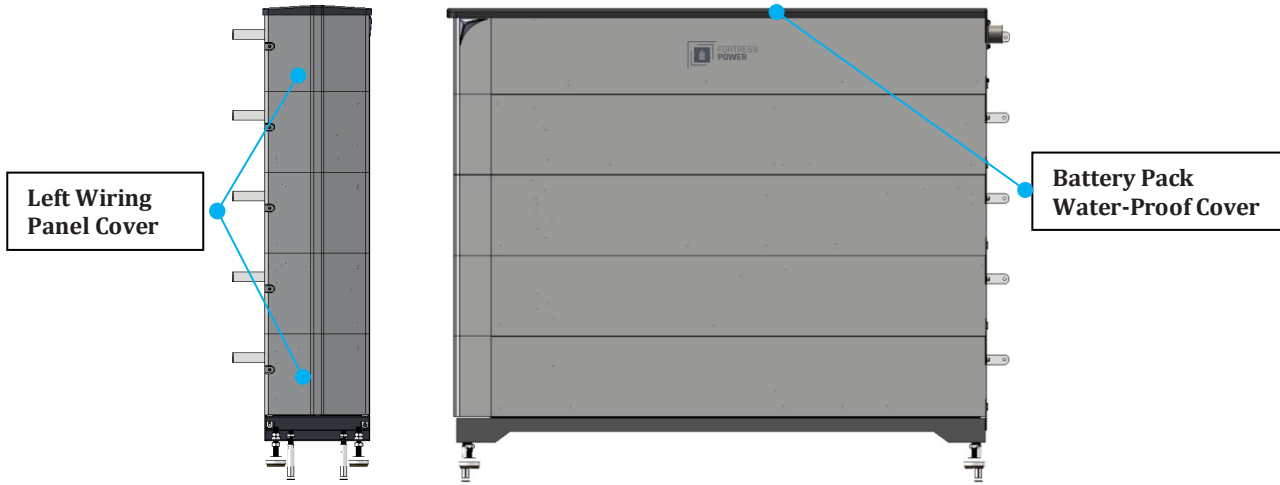

Figure 5.42 Battery Pack Final Assembly

6. COMMISSIONING OPERATION AND MAINTAINANCE

6.1. Commissioning Check List

Before commissioning the Avalon ESS, the following should be checked thoroughly.

6.1.1. System Check List

- Ensure each equipment is mounted and anchored per manufacturer recommendation and local requirements.
- Ensure SPE grid input breaker is switched “OFF”.
- Ensure Hybrid Inverter DC and AC switches are in the “OFF” position.
- Ensure HV Battery DC breaker and Power button are switched “OFF”.

- Check cables for any possible damage or cracks.
- Check cable terminations and each is firmly crimped on the cable.
- Check all cables are connected according to the cable connection diagrams.
- Check all the cable connection terminals are locked securely and all bolts/screws are fastened properly.
- Adjust the cable routing and tie cable bundle to a fixed spot if necessary.
- Ensure all cable connections meet related standards and requirements.
- Ensure the system is properly grounded. Ground resistance should be less than 4 Ω .

6.1.2. Checking Grid Voltage

- Ensure SEP grid input breaker is switched “OFF”
- Use digital multimeter to verify the grid voltage and frequency L1-L2, L1-N, and L2-N & Hz?

6.1.3. Checking the Hybrid Inverter

- Ensure the DC and AC switches are in the “OFF” position.
- Check PV DC voltage meets Hybrid Inverter requirements, and the polarity is correct.
- Check Battery DC input polarity is correct.

6.1.4. Checking the HV Battery

- Ensure the DC breaker is switched “OFF”.
- Check Battery DC voltage meets Hybrid Inverter requirements, and the polarity is correct.

6.1.5. Other Preparations before Starting

- Nothing should be stored directly on top, underneath, or against any Avalon ESS equipment.
- Clean the equipment site and ensure the environment is clean without flammable or explosive materials.

6.2. Power Up/Down and E-Stop Sequence

6.2.1. Turn On the System

If all tests and measurements have been performed, and all measured values are within the acceptable range, the Avalon system can be switched on for the first time.

- Proceed as follows to start the Avalon ESS:
- Start from Battery pack, switch BMS DC breaker to “ON” position, push inward Power switch to “ON” position. Wait for the status indicator LED to turn green.
- Followed by Hybrid Inverter, switch the AC switch to Inverter position, switch on any upstream disconnect switch from PV array, then switch inverter DC switch to “ON”.
- Switch on any upstream disconnect supplying 240Vac power to the SEP.
- Close all breakers in the SEP. Wait five minutes for the inverter to connect to the grid. Check inverter LED display for normal operation state.
- Check SEP HMI LCD for normal operation state, set SEP to commissioning mode if not already in this mode.
- Start Fortress Power Installer App to commission Avalon ESS. Detailed App operation and commissioning steps are in << Fortress Power Installer App Quick Setup Guide>>.

6.2.2. Shutdown the System

Warning. Do not disconnect battery, PV, and AC power under load.

- Turn the E-stop to “Stop” position will shut down the entire ESS.
- Turn off the grid only, switch the grid breaker in SEP to “OFF”.
- Turn off the inverter only, switch the inverter AC switch to OFF.
- Turn off the battery only, switch the BMS DC breaker to “OFF”, and watch the inverter LED screen turn off. Can use battery pushbutton Power switch to turn off the battery.
- Turn off any upstream or downstream AC/DC disconnect switches.

6.2.3. Restart the System

To restart the Avalon system after a shutdown.

- Switch BMS DC breaker to “ON” position, push inward Power switch to “ON” position. Wait for the status indicator LED to turn green.
- Switch the inverter AC switch to Inverter position, switch on any upstream disconnect switch from PV array, then switch inverter DC switch to “ON”.
- Switch on any upstream disconnect supplying 240Vac power to the SEP.
- Switch on all breakers in the SEP. Wait five minutes for the inverter to connect to the grid. Check inverter LED display for normal operation state.
- Check SEP HMI LCD for normal operation state.

After the commissioning steps are completed and saved in the App, the Avalon ESS will automatically detect the parameters such as the AC grid code, DC voltage, power, and ground impedance, etc. Upon confirmation that these parameters are in line with grid-connected operation requirements, the ESS will automatically enter the “Run” mode to power all configured loads.



WARNING

If the DC breaker is NOT turned on as per the start-up procedure or if the AC and DC inverter and battery breakers and switches are disconnected when the inverter is under load in normal operation, electric arc can occur and can damage the internal components.

6.3. Commissioning with Installer App

Please follow <<Fortress Power Installer App Quick Guide>> to commission Avalon ESS.

Download the iOS or **Android** “Fortress Installer” App.

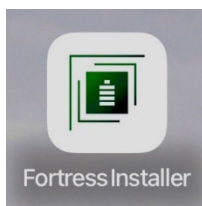

App Store

6.4. LCD Display and Operation



Figure 6.1 SEP HMI LCD Display and Control

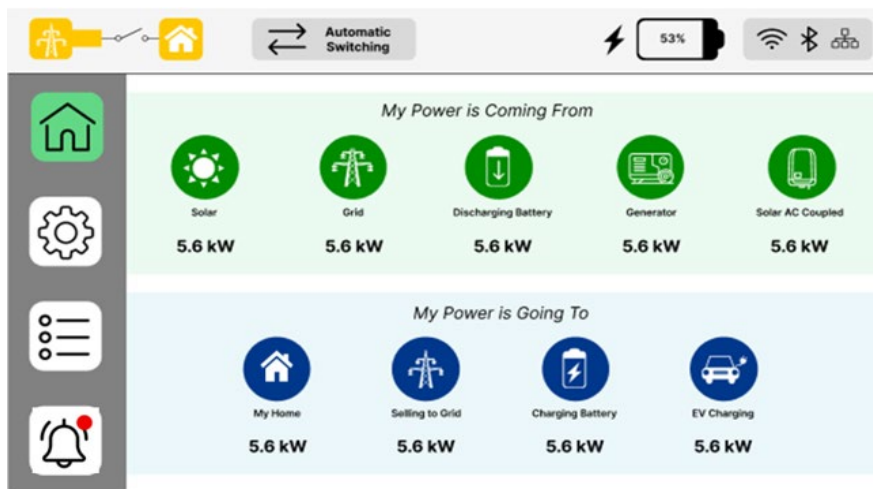

Figure 6.2 SEP HMI LCD Home Page

The HMI LCD screen on the SEP offers a user-friendly interface for basic monitoring, configuration, and alarm reporting of the Avalon ESS. It is designed to provide essential information, settings, and status of the system operation. User control can either via the touch screen or the push buttons on the right side of the panel. This interface is ideal for quickly checking the system status, adjusting basic settings, and receiving alerts or alarms.

Please follow <<Avalon Smart Energy Panel HMI User Guide>> to navigate and operate SEP HMI LCD display.

6.5. System Operation and Maintenance

6.5.1. Normal Operation

In normal operating conditions no user interaction is required. Operational status should be monitored periodically by online monitoring or locally on the SEP LCD screen or Homeowner App.

6.5.2. Making Changes to Load Circuits

If need to add/delete/re-wire any load circuit to/from ESS, the system must be shut down and use FP Installer App to re-config Avalon ESS.

- Follow shutdown sequence in the commissioning section to properly turn off the ESS.
- Perform the physical connection, disconnect and wiring of the appliance.
- Follow power up sequence in the commissioning section to properly turn ESS back on.
- Set SEP into commissioning mode.
- Use FP Installer App to config new load shedding setup for the appliance.

6.5.3. Maintenance and Troubleshooting Safety Guide

When the product needs maintenance, all circuit breakers and relays must be disconnected before attempting to remove any cables. Make sure with a multimeter that all exposed cables do not have electrical voltage to avoid electric shock.

Troubleshooting of any Avalon ESS problem is primarily accomplished through troubleshooting individual battery, inverter, and SEP or monitoring components. Please refer to the troubleshooting section below. For technical support, please fill out a support ticket at <https://support.fortresspower.com>.

1. Disconnect External Power Supply:
 - Grid Power Input: Switch off the grid power input to the system. This isolates the system from the utility power supply.
 - PV Inverter Power Input: Turn off the DC power input from the PV inverter. This ensures the system is disconnected from solar energy sources.
 - Activate Emergency Stop (E-Stop): Engage the E-Stop on SEP by setting it to "Stop". This action cuts off power to most control boards and stops all operational processes.
 - Turn Off Hybrid Inverter: Switch off the Avalon HV Hybrid Inverter using its designated power switches to completely isolate it from all power sources.
2. Battery Power Disconnection:
 - Switch Off Battery Breaker: Locate and turn off the battery breaker to isolate the battery from the system.
 - Power Cycle Battery: If the battery has a power cycle button, use it to ensure the battery is fully powered down.
 - Verify Complete Power Isolation: Conduct a thorough check with a multimeter to ensure there is no residual voltage in the system, confirming complete power isolation.
3. Wear Personal Protective Equipment (PPE):
 - Always use appropriate PPE, like electrical gloves and safety glasses, during maintenance to protect against electrical hazards.
4. System Power Restoration:
 - After maintenance is complete, carefully restore power to the system per user manual.
 - This includes reactivating the battery breaker, disengaging the E-Stop, and powering on the hybrid inverter to ensure safe and efficient system handling.

6.5.4. Maintenance Tasks

Because of ambient temperature, humidity, dust, and vibration, the Avalon ESS and the inner components will age and wear out. To ensure the system safety and maintain the efficiency of the ESS system, it is necessary to carry out periodic maintenance on the system by visually inspecting for any dust or humidity ingress.

Non-routine maintenance including firmware updates, fuse replacements, BMS replacements, or other material swaps, all should be performed in accordance with local jurisdictional requirements and logged by support ticket at <https://support.fortresspower.com>. Please consult with Fortress Power technical support for proper procedures of these non-routine maintenance items.

Check Fortress Power website for any firmware update instructions to determine if a firmware update is necessary.

FORTRESS POWER AVALON HIGH VOLTAGE ENERGY STORAGE SYSTEM

Item	Method	Interval
Site Check	Check to ensure no flammable materials are stored around the Avalon, or other objects or site conditions that may impair the system's safe operation.	Quarterly
Basic Performance Check	Visually inspect HMI LCD screen or online monitoring system for any warning or alerts. Confirm that energy flowing of the ESS.	Quarterly
Dust Inspection	Check if the ESS doors can close and open freely. Check if the sealing strip is sealed properly. If significant dust is found inside the SEP and/or inverter cabinet, thoroughly clean any dust using a vacuum cleaner. Check the air inlet and outlet, and clean dust if necessary.	Annually
Device maintenance	Visually check for corrosion at each piece of equipment components. Verify power is flowing through all available sources and to all available loads. Verify battery voltage is staying within operating parameters.	Annually
Software maintenance	Check Fortress Power website for latest firmware update instructions. Firmware update instructions are device specific.	Annually
Cable Connection	Check all power cables for loose connection or insulation breakdown or corrosion. Check if all cable entries are sealed properly. Check if there is water leakage inside the SEP, inverter and battery. Retighten loose cable, clean or change damaged cable.	Every three years
Battery Cleaning	Only clean the Battery pack when significant amounts of dust and dirt are found in other cabinets. Retorque the battery terminals after vacuuming any dust. Check Operating status LED indicators are still working.	Infrequent

6.5.5. Troubleshooting Guide

Fault, consequence and troubleshooting chart here.

7. Appendix

7.1. Avalon ESS Reference Design – 200A Service Entrance

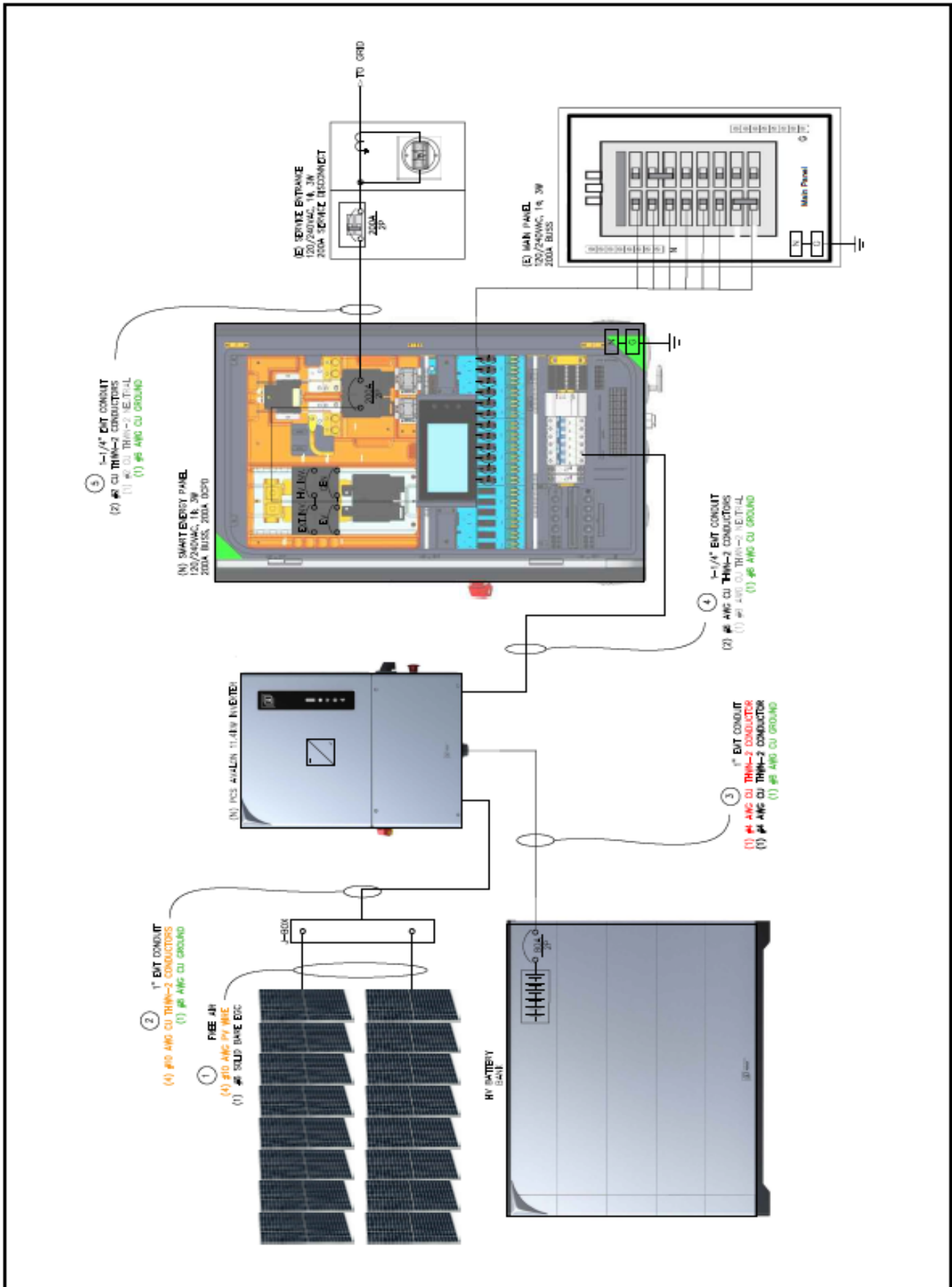

7.3. Avalon Smart Energy Panel Technical Parameters

Performance

AC voltage	120/240 V
feed-in type	split phase
grid frequency	60 Hz
current rating	200 A
max input short circuit current	10 kA, 15 kA, or 25 kA*
overcurrent protection device	100 - 200A; service entrance rated
AC meter	non-RGM is standard, Revenue Grade Meter is optional
primary connectivity	ethernet / wifi / bluetooth
user interface	Fortress App
backup transition	automatic transfer for backup
expandability	supports up to 3 Avalon HV hybrid inverters, up to 35 kW backup load
limited warranty	5 years

Mechanical

dimensions	35.4 x 22.2 x 9.45in (900 x 565 x 240mm)
weight	55 lbs (25 kg)
mounting options	wall mount

Electrical Connections

smart load control	12 positions. Control up to 12 single phase loads (120V), 6 split phase loads (240V), or any combination, up to 50A
smart load control modes	automatic, scheduled, or manual control
EV charging smart load provision	up to 50A
AC coupling smart load provision	up to 50A
generator smart load provision	up to 50A
non-backup lug connections	included

Environmental

operating temperature	-4°F to 122°F (-20°C to 50°C)
operating humidity	up to 100%, condensing
maximum elevation	9,843 ft (3000m)
environment	indoor and outdoor rated
enclosure type	NEMA 3R

Compliance & Certificates

certifications	UL67, UL1741 PCS, UL869A, UL916
emissions	FCC Part 15, ICES 003

Accessories (not included, unless otherwise noted)

main breaker	Eaton CSR2200N, 2pole/200A
PCS inverter backup breaker	Eaton BR2600rBR2125, 1or2or3pole/60Aor125A/25kAIC
PCS inverter DIN rail breaker (included in inverter packaging)	B1N1C40, 1 pole / 40A, for 7.6kW Avalon inverter B1N1C60, 1 pole / 60A, for 11.4kW Avalon inverter
other system components (EV, AC coupled inverter, generator)	based on component spec
hold down kit	Eaton X-IQ-NA-HD-200A with screws

Table 7.1 SEP Technical Parameters

7.4. Avalon HV Hybrid Inverter Technical Parameters

DC Input (PV)

max. input voltage	600 V
rated voltage	380 V
start-up voltage	80 V
MPPT voltage range	80 - 520 V A
max. input current per string	16 A
max. short circuit current per string	25.6 A
number of MPPTs/number of strings per MPPT	4/1

AC Output

	7.6	11.4
rated output power	7.6 kW	11.4 kW
max. apparent output power (grid)	7.6 kVa	11.4 kVa
max. apparent output power (off-grid)	12.2 kVa, 10 sec	18.2 kVa, 10 sec
back-up switch time	<10 ms	
rated output voltage (L1-L2)	240 V	
rated output voltage (L1/L2-N)	120 V	
AC output voltage range	211 - 264 V	
rated frequency	60 Hz	
frequency range	55 - 65 Hz	
rated output current	31.7 A	47.5 A
max. output current (grid)	31.7 A	47.5 A
max. output overcurrent, 10 sec (off-grid)	50.7 A	76 A
max. allowance phase configurations	100 %	
backup support configurations	whole-home and dedicated loads	
power factor	>0.99 (0.8 leading - 0.8n lagging)	
THD	<3%	

AC Input (Grid)

	7.6	11.4
input voltage range	211 - 264 V	
frequency range	58.8 - 61.2 Hz	

Efficiency

PV max. efficiency	97.6%
PV CEC efficiency	97.2 %
battery charged by PV max. efficiency	98.5%
battery charged/discharged to AC max. efficiency	97.0%

Protection

ground fault detection	yes
residual (leakage) current detection	yes
integrated AFCI (DC arc-fault circuit protection)	yes
DC reverse-polarity protection	yes (PV only)
rapid shutdown NEC 2017	integrated sunspec-certified transmitter
RSD receiver	APSmart or Tigo
manual inverter bypass switch	yes

Energy Storage

battery voltage range	120-315 V
maximum charge/discharge current	50 A
battery communication	CAN/RS485

General Data

dimensions (W*H*D)	21.87*34.88*8.62 in (555.5*866*219mm)
weight	89.59 lbs (40.64 kgs)
mounting	wall mount
topology	transformerless
operation temperature range	-13°F to 140°F (-25°C to 60°C)
ingress protection	TYPE 4X (IP66)
noise emission	fan-less, <30 dB(A)
cooling method	natural convection
maximum elevation	9,843 ft (3000m)
compliance	UL 1741, UL 1741 SA, UL 1741 SB, UL9540, IEEE 1547-2018, IEEE 1547J-2020, UL 1699B, UL 1998, California Rule 21, HECO Rule 14H, NEC 090.12-2020, CAN/CSA C22.2107J-1, FCC Part 15 Class B
generator support	yes
limited warranty	10 years

Table 7.2 Hybrid Inverter Technical Parameters

7.5. Avalon HV BMS and Battery Module Technical Parameters

Specifications

battery modules	3	4	5	6
nominal voltage (V)	144	192	240	288
operation voltage range (V)	119.25 ~ 157.5	159 ~ 210	198.75 ~ 262.5	238.5 ~ 315
nominal capacity (Ah)	102	102	102	102
nominal energy (kWh)	14.7	19.6	24.5	29.4
nominal charge/discharge current (A)	50	50	50	50
maximum surge rate	80A, 15 sec	80A, 15 sec	80A, 15 sec	80A, 15 sec
maximum units in parallel	4	4	4	4
limited warranty (years)	15	15	15	15
cycle life @ EOL 70%	8,000	8,000	8,000	8,000
communication protocol	CAN	CAN	CAN	CAN
weight	302 lbs (137 kg)	392.4 lbs (178 kg)	482.8 lbs (219 kg)	573.2 lbs (260 kg)
size (LxHxD)	43 x 28.15 x 10.96 in (1092 x 715 x 278.4 mm)	43 x 34.72 x 10.96 in (1092 x 881.8 x 278.4 mm)	43 x 41.3 x 10.96 in (1092 x 1049 x 278.4 mm)	43 x 47.87 x 10.96 in (1092 x 1215.9 x 278.4 mm)
ingress protection	IP65	IP65	IP65	IP65
operation temperature	charge: -10°C to 50°C discharge: -20°C to 55°C	charge: -10°C to 50°C discharge: -20°C to 55°C	charge: -10°C to 50°C discharge: -20°C to 55°C	charge: -10°C to 50°C discharge: -20°C to 55°C
certifications	UL1973, UL9540, UL9540A, CEC, SGIP, AC156	UL1973, UL9540, UL9540A, CEC, SGIP, AC156	UL1973, UL9540, UL9540A, CEC, SGIP, AC156	UL1973, UL9540, UL9540A, CEC, SGIP, AC156
transportation classification	UN3480, Class 9	UN3480, Class 9	UN3480, Class 9	UN3480, Class 9

Table 7.3 Hybrid Inverter Technical Parameters

Fortress Power, LLC

2010 Cabot Blvd, Langhorne, PA 19047

Tel: +1(877) 497-6937

Email: sales@fortresspower.com

Web: www.fortresspower.com

If you encounter any problems with the Avalon ESS, please take note of the ESS serial number and then contact us using the phone number or email listed above.